



Panasonic®

Personal Computer

OPERATING INSTRUCTIONS

Model No. **CF-73 Series**

Contents

Getting Started

Read Me First.....	3
First-time Operation	11

Reference Manual

- Read Me First
- Key Combinations
- LED Indicators

Operation

Starting Up/Shutting Down	16
Touch Pad	19
Reference Manual	20

Reference Manual

- Touch Pad
- Touchscreen*
- Standby/Hibernation Functions
- Security Measures
- Computing on the Road
- Battery Power
- Multimedia Pocket
- CD Drive
- PC Cards
- RAM Module
- Port Replicator
- Printer
- External Display
- USB Devices
- Modem
- LAN
- Wireless LAN
- Hard Disk Drive
- Setup Utility
- * Only for models with touchscreen

Troubleshooting

List of Error Codes	21
Dealing with Problems (Summary)	23
Reinstalling Software	27

Reference Manual

- Technical Information
- DMI Viewer
- List of Error Codes
- Dealing with Problems (Advanced)

Appendix

LIMITED USE LICENSE AGREEMENT	29
Hard Disk Data Erase Utility	31
WinDVD™	32
Names and Functions of Parts	34
Specifications	36
LIMITED WARRANTY	38

2000 XP

[Additional Manual]

Reference Manual

This manual can be accessed on your computer. Refer to page 20 on how to access the Reference Manual.

Getting Started

Operation

Troubleshooting

Appendix

Customer's Record



Model No. *	Dealer's Name
Serial No.	
or	
Code No.	Dealer's Address
Date of Purchase	

* For the Model No., insert the 12 digit number (for example, CF-73E3KVXDM) located on the bottom of the computer.

Introduction

Thank you for purchasing the Panasonic computer. Read the operating instructions thoroughly for proper operation of your new computer.

Illustrations and Terminology in this Manual

- NOTE:** **NOTE** provides a useful fact or helpful information.
- CAUTION:** **CAUTION** indicates a condition that may result in minor or moderate injury.
- WARNING:** **WARNING** indicates a hazard that may result in moderate or serious injury.
- Windows 2000** : Information for Microsoft® Windows® 2000 Professional users.
- Windows XP** : Information for Microsoft® Windows® XP Professional users.
- Enter** : This illustration means to press the [Enter] key.
- Fn** + **F5** : This illustration means to press and hold the [Fn] key, then press the [F5] key.
- [Start] - [Run]: This illustration means to click [Start], then to click [Run].
(For some applications, you may need to double-click.)
-  : Where to go for referred information.
-  Reference Manual : This illustration means to refer to the Reference Manual, which is available on your computer. Refer to page 20 on how to access this manual.
- Windows 2000 screens are used in this manual when no specific OS notes are required.
 - Some of the illustrations in this manual may differ slightly in shape from the actual items in order to make the explanation easier to understand.
 - Circular media such as DVD-ROM and CD-ROM are described as “discs”.
 - The following drives are described as “CD drive”.
DVD-ROM drive, DVD-ROM & CD-R/RW drive
 - If the user has logged on without the administrator authority, some functions may not be executable, and some screens may not be displayed as shown in this manual. If this happens, log on with the administrator authority to enable these functions.
 - Confirm the latest information on optional products in catalogs, etc.

Copyright

This manual is copyrighted by Matsushita Electric Industrial Co., Ltd. with all rights reserved. No part of this manual may be reproduced in any form without the prior written permission of Matsushita Electric Industrial Co., Ltd. No patent liability is assumed with respect to the use of the information contained herein.

©2003 Matsushita Electric Industrial Co., Ltd. All Rights Reserved.

Disclaimer

Computer specifications and manuals are subject to change without notice. Matsushita Electric Industrial Co., Ltd. assumes no liability for damage incurred directly or indirectly from errors, omissions or discrepancies between the computer and the manuals.

Trademarks

Microsoft, Windows, Windows NT and the Windows logo are registered trademarks of Microsoft Corporation of the United States and/or other countries.

Intel, Pentium and SpeedStep are either registered trademarks or trademarks of Intel Corporation.

Adobe® and Acrobat® are either registered trademarks or trademarks of Adobe Systems Incorporated in the United States and/or other countries.

WinDVD™ is a trademark of InterVideo, Inc.

Roxio, the Roxio logo, Easy CD Creator and DirectCD are trademarks of Roxio, Inc. which may be registered in some jurisdictions.

Panasonic is a registered trademark of Matsushita Electric Industrial Co., Ltd.

Read Me First

For U.S.A.

Federal Communications Commission Radio Frequency Interference Statement

Note: This equipment has been tested and found to comply with the limits for a Class B digital device, pursuant to Part 15 of the FCC Rules. These limits are designed to provide reasonable protection against harmful interference in a residential installation. This equipment generates, uses and can radiate radio frequency energy and, if not installed and used in accordance with the instructions, may cause harmful interference to radio communications. However, there is no guarantee that interference will not occur in a particular installation. If this equipment does cause harmful interference to radio or television reception, which can be determined by turning the equipment off and on, the user is encouraged to try to correct the interference by one or more of the following measures:

- Reorient or relocate the receiving antenna.
- Increase the separation between the equipment and receiver.
- Connect the equipment into an outlet on a circuit different from that to which the receiver is connected.
- Consult the Panasonic Service Center or an experienced radio/TV technician for help.

Warning

To assure continued compliance, use only shielded interface cables when connecting to a computer or peripheral. Also, any changes or modifications not expressly approved by the party responsible for compliance could void the user's authority to operate this equipment.

FCC RF Exposure Warning: This computer is provided with PC Card slots that could be used with wireless transmitter(s), which will be specifically recommended, when they become available. Other third-party wireless transmitter(s) have not been RF exposure evaluated for use with this computer and may not comply with FCC RF exposure requirements.

This device complies with Part 15 of the FCC Rules. Operation is subject to the following two conditions:

- (1) This device may not cause harmful interference, and
- (2) This device must accept any interference received, including interference that may cause undesired operation.

Responsible Party: Matsushita Electric Corporation of America
One Panasonic Way
Secaucus, NJ 07094
Tel No: 1-800-LAPTOP-5 (1-800-527-8675)

IMPORTANT NOTE: To comply with FCC RF exposure compliance requirements, the antenna used for this transmitter must be installed to provide a separation distance of at least 20 cm from all persons and must not be co-located or operating in conjunction with any other antenna or transmitter.

FCC Regulation Notice for modem This equipment contains a FCC approved modem.

Manufacturer of modem: PC TEL Inc.
Model No. PCT2304WT

Tested To Comply With FCC Standards FOR HOME OR OFFICE USE

1. This equipment complies with CFR47 Part 68 rules. On the computer is a label that contains, among other information, the FCC registration number and ringer equivalence number (REN) for this equipment. If required, this information must be provided to the telephone company.
2. An FCC compliant telephone cord and modular plug is provided with this equipment. This equipment is designed to be connected to the telephone network or premises wiring using a compatible modular jack which is Part 68 compliant. See Installation Instructions for details.
3. The REN is used to determine the quantity of devices which may be connected to the telephone line. Excessive RENs on the telephone line may result in the devices not ringing in response to an incoming call. In most, but not all area, the sum of RENs should not exceed five (5.0). To be certain of the number of devices that may be connected to a line, as determined by the total RENs, contact the local telephone company.
4. If your telephone equipment cause harm to the telephone network, the telephone company will notify you in advance that temporary discontinuance of service may be required. But if advice notice isn't practical, the telephone company will notify the customer as soon as possible. Also, you will be advised of your right to file a complaint with the FCC if you believe it is necessary.
5. The telephone company may take changes in it's facilities, equipment, operations or procedures that could affect the operation of the equipment. If this happens the telephone company will provide advance notice in order for you to make necessary modifications to maintain uninterrupted service.
6. If trouble is experienced with this equipment, for repair or warranty information, please contact Matsushita Electric Corporation of America at DIAL TOLL FREE 1-800-LAPTOP5 (1-800-527-8675). If the equipment is causing harm to the telephone network, the telephone company may request that you disconnect the equipment until the problem is resolved.
7. There are no user serviceable parts contained in this equipment.
8. This equipment may not be used on coin service provided by the telephone company. Connection to party lines is subject to state tariffs.
9. The Telephone Consumer Protection Act of 1991 makes it unlawful for any person to use a computer or other electronic device to send any message via a telephone fax machine unless such message clearly contains in a margin at the top or bottom of each transmitted page or on the first page of the transmission, the date and time it is sent and an identification of the business or other entry, or other individual sending the message and the telephone number of the sending machine or such business, other entity, or individual. In order to program this information into your fax software, you should refer to the manual of the Fax software being used.

Read Me First

10. According to the FCC's electrical safety advisory, we recommend that you may install an AC surge arrester in the AC outlet to which this equipment is connected. Telephone companies report that electrical surges, typically lightning transients, are very destructive to customer terminal equipment connected to AC power sources and that this is a major nationwide problem.

"Caution: To reduce the risk of fire, use only No.26 AWG or larger telecommunication line cord."

"ATTENTION: Pour réduire le risque d'incendie, utiliser uniquement des conducteurs de télécommunications 26 AWG ou de section supérieure."

For Canada

Industry Canada (IC) Notice for modem

This equipment contains an Industry Canada approved modem unit. The Industry Canada label is affixed on the modem unit.

EQUIPMENT ATTACHMENT LIMITATIONS

"NOTICE: The Industry Canada label identifies certified equipment. This certification means that the equipment meets telecommunications network protective, operational and safety requirements as prescribed in the appropriate Terminal Equipment Technical Requirements document(s). The Department does not guarantee the equipment will operate to the user's satisfaction.

Before installing this equipment, users should ensure that it is permissible to be connected to the facilities of the local telecommunications company. The equipment must also be installed using an acceptable method of connection. The customer should be aware that compliance with the above conditions may not prevent degradation of service in some situations.

Repairs to certified equipment should be coordinated by a representative designated by the supplier. Any repairs or alterations made by the user to this equipment, or equipment malfunctions, may give the telecommunications company cause to request the user to disconnect the equipment.

Users should ensure for their own protection that the electrical ground connections of the power utility, telephone lines and internal metallic water pipe system, if present, are connected together. This precaution may be particularly important in rural areas. Caution: Users should not attempt to make such connections themselves, but should contact the appropriate electric inspection authority, or electrician, as appropriate."

"NOTICE: The Ringer Equivalence Number (REN) assigned to each terminal device provides an indication of the maximum number of terminals allowed to be connected to a telephone interface. The termination on an interface may consist of any combination of devices subject only to the requirement that the sum of the Ringer Equivalence Numbers of all the devices does not exceed 5."

REN: See bottom of the computer

Notice for the products using LCD

This product uses one or more fluorescent lamps containing a small amount of mercury. It also contains lead in some components. Disposal of these materials may be regulated in your community due to environmental considerations. For disposal or recycling information please contact your local authorities, or the Electronics Industries Alliance: <<http://www.eiae.org/>>

RESTRICTIONS CONCERNANT LE RACCORDEMENT DE MATÉRIEL

"AVIS: L'étiquette d'Industrie Canada identifie le matériel homologué. Cette étiquette certifie que le matériel est conforme aux normes de protection, d'exploitation et de sécurité des réseaux de télécommunications, comme le prescrivent les documents concernant les exigences techniques relatives au matériel terminal. Le Ministère n'assure toutefois pas que le matériel fonctionnera à la satisfaction de l'utilisateur.

Avant d'installer ce matériel, l'utilisateur doit s'assurer qu'il est permis de le raccorder aux installations de l'entreprise locale de télécommunication. Le matériel doit également être installé en suivant une méthode acceptée de raccordement. L'abonné ne doit pas oublier qu'il est possible que la conformité aux conditions énoncées ci-dessus n'empêche pas la dégradation du service dans certaines situations.

Les réparations de matériel homologué doivent être coordonnées par un représentant désigné par le fournisseur. L'entreprise de télécommunications peut demander à l'utilisateur de débrancher un appareil à la suite de réparations ou de modifications effectuées par l'utilisateur ou à cause de mauvais fonctionnement.

Pour sa propre protection, l'utilisateur doit s'assurer que tous les fils de mise à la terre de la source d'énergie électrique, des lignes téléphoniques et des canalisations d'eau métalliques, s'il y en a, sont raccordés ensemble. Cette précaution est particulièrement importante dans les régions rurales. Avertissement: L'utilisateur ne doit pas tenter de faire ces raccordements lui-même; il doit avoir recours à un service d'inspection des installations électriques, ou à un électricien, selon le cas."

"AVIS: L'indice d'équivalence de la sonnerie (IES) assigné à chaque dispositif terminal indique le nombre maximal de terminaux qui peuvent être raccordés à une interface. La terminaison d'une interface téléphonique peut consister en une combinaison de quelques dispositifs, à la seule condition que la somme d'indices d'équivalence de la sonnerie de tous les dispositifs n'excède pas 5."

IES: Voir sous le fond de l'ordinateur

Industry Canada

This product complies with RSS210 Industry Canada.

Operation is subject to the following two conditions;

- (1) this device may not cause interference, and
- (2) this device must accept any interference, including interference that may cause undesired operation of the device.

Important Safety Instructions / Importantes Mesures De Sécurité

When using your telephone equipment, basic safety precautions should always be followed to reduce the risk of fire, electric shock and injury to persons, including the following:

1. Do not use this product near water, for example, near a bath tub, wash bowl, kitchen sink or laundry tub, in a wet basement or near a swimming pool.
2. Avoid using a telephone (other than a cordless type) during an electrical storm. There may be a remote risk of electric shock from lightning.
3. Do not use the telephone to report a gas leak in the vicinity of the leak.
4. Use only the power cord and batteries indicated in this manual. Do not dispose of batteries in a fire. They may explode. Check with local codes for possible special disposal instructions.

SAVE THESE INSTRUCTIONS

Certaines mesures de sécurité doivent être prises pendant l'utilisation de matériel téléphonique afin de réduire les risques d'incendie, de choc électrique et de blessures. En voici quelquesunes:

1. Ne pas utiliser l'appareil près de l'eau, p.ex., près d'une baignoire, d'un lavabo, d'un évier de cuisine, d'un bac à laver, dans un sous-sol humide ou près d'une piscine.
2. Éviter d'utiliser le téléphone (sauf s'il s'agit d'un appareil sans fil) pendant un orage électrique. Ceci peut présenter un risque de choc électrique causé par la foudre.
3. Ne pas utiliser l'appareil téléphonique pour signaler une fuite de gaz s'il est situé près de la fuite.
4. Utiliser seulement le cordon d'alimentation et le type de piles indiqués dans ce manuel. Ne pas jeter les piles dans le feu: elles peuvent exploser. Se conformer aux règlements pertinents quant à l'élimination des piles.

CONSERVER CES INSTRUCTIONS

Getting Started

Information to the User

This product and your Health

This product, like other radio devices, emits radio frequency electromagnetic energy. The level of energy emitted by this product however is far much less than the electromagnetic energy emitted by wireless devices like for example mobile phones.

Because this product operates within the guidelines found in radio frequency safety standards and recommendations, we believe this product is safe for use by consumers. These standards and recommendations reflect the consensus of the scientific community and result from deliberations of panels and committees of scientists who continually review and interpret the extensive research literature.

In some situations or environments, the use of this product may be restricted by the proprietor of the building or responsible representatives of the organization. These situations may for example include:

- Using this product on board of airplanes, or
 - In any other environment where the risk of interference to other devices or services is perceived or identified as harmful.
- If you are uncertain of the policy that applies on the use of wireless devices in a specific organization or environment (e.g. airports), you are encouraged to ask for authorization to use this product prior to turning on the product.

Regulatory Information

We are not responsible for any radio or television interference caused by unauthorized modification of this product. The correction of interference caused by such unauthorized modification will be the responsibility of the user. We and its authorized resellers or distributors are not liable for damage or violation of government regulations that may arise from failing to comply with these guidelines.

Informations destinées à l'utilisateur

Cet appareil et votre santé

Cet appareil, comme les autres dispositifs radio, émet une énergie électromagnétique de fréquence radio. Le niveau d'énergie émis par cet appareil est cependant bien inférieur à l'énergie électromagnétique émise par certains dispositifs sans fil comme, par exemple, les téléphones portables.

Cet appareil fonctionnant dans les limites des directives concernant les normes et recommandations de sécurité des fréquences radio, nous pensons que l'utilisation de cet appareil ne pose aucun risque pour les consommateurs. Ces normes et recommandations reflètent le consensus de la communauté scientifique et découlent des délibérations de commissions et comités de scientifiques qui examinent continuellement et interprètent les documents de travaux approfondis. Dans certaines situations ou certains lieux, l'utilisation de cet appareil peut être restreinte par le propriétaire du bâtiment ou les responsables de l'organisation. Par exemple, ces situations peuvent inclure :

- L'utilisation de cet appareil à bord d'un avion, ou
 - Dans un autre milieu où le risque d'interférence avec d'autres dispositifs ou services est perçu ou identifié comme nuisible.
- Si vous n'êtes pas sûr de la politique qui s'applique à l'utilisation de dispositifs sans fil dans une organisation ou lieu spécifique (un aéroport, par exemple), il est conseillé de demander l'autorisation d'utiliser cet appareil avant de le mettre sous tension.

Informations sur la réglementation

Nous ne serons pas tenus responsables de parasites radioélectriques ou de télévision provoqués par une modification non autorisée de cet appareil. La rectification des parasites provoqués par une telle modification non autorisée sera la responsabilité de l'utilisateur. Nous, et les revendeurs ou distributeurs mandatés de l'appareil ne seront pas tenus responsables de dommages ou violations de règlements gouvernementaux qui peuvent se produire du fait du non respect de ces directives.

Lithium Battery

Lithium Battery!

This computer contains a lithium battery to enable the date, time, and other data to be stored. The battery should only be exchanged by authorized service personnel.

Warning! A risk of explosion from incorrect installation or misapplication may possibly occur.

Pile au lithium!

Le micro-ordinateur renferme une pile au lithium qui permet de sauvegarder certaines données comme la date et l'heure notamment. Elle ne devra être remplacée que par un technicien qualifié.

Avertissement! Risque d'explosion en cas de non respect de cette mise en garde!

CD Drive Caution

CAUTION!

THIS PRODUCT UTILIZES A LASER.
USE OF CONTROLS, ADJUSTMENTS OR PERFORMANCE OF PROCEDURES OTHER THAN THOSE SPECIFIED HEREIN MAY RESULT IN HAZARDOUS RADIATION EXPOSURE.
DO NOT OPEN COVERS AND DO NOT REPAIR YOURSELF.
REFER SERVICING TO QUALIFIED PERSONNEL

AVERTISSEMENT!

CET APPAREIL UTILISE UN LASER.
L'UTILISATION DE COMMANDES OU DE RÉGLAGES OU L'EXÉCUTION DE PROCÉDURES AUTRES QUE CELLES SPÉCIFIÉES ICI PEUVENT PROVOQUER UNE EXPOSITION À DES RADIATIONS DANGEREUSES.
NE PAS OUVRIR LES COUVERCLES NI ESSAYER DE RÉPARER SOI-MÊME.
CONFIER TOUT TRAVAIL D'ENTRETIEN À UN PERSONNEL QUALIFIÉ.

Bottom

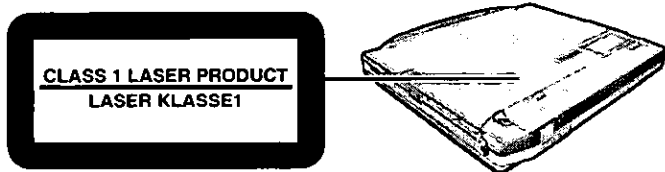

Laser safety information is appropriate only when drive with laser is installed.

Les mesures de sécurité relatives au laser ne s'appliquent que lors de l'installation d'une unité avec laser.

Precautions

This computer has been designed so as to minimize shock to the LCD and hard disk drive, the leakage of liquid (e.g., water) on to the keyboard, etc., but no warranty is provided against such trouble. Therefore, as a precision instrument, be extremely careful in the handling.

Before putting the computer away, be sure to wipe off any moisture.

● Usage

Avoid Extreme Heat and Cold

Do not store or use the computer in locations exposed to heat, direct sunlight, or extreme cold. Avoid moving the computer between locations with large temperature difference.

Operation: 5 °C to 35 °C {41 °F to 95 °F}

Storage: -20 °C to 60 °C {-4 °F to 140 °F}



Avoid Direct Sunlight on the LCD Panel

The LCD panel should not be exposed to direct sunlight or ultraviolet light.



Avoid Humidity, Liquids and Dust

Do not store or use the computer in locations exposed to high humidity, liquids (including rain) or dust.



Prevent Shock

Avoid subjecting the computer to severe vibrations or impact. Do not place the computer inside a car trunk.

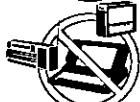

Avoid Radio Frequency Interference

Do not place the computer near a television or radio receiver.



Avoiding low-temperature burns

Avoid more than casual contact with any heat producing area of the notebook computer, AC adaptor, and any option or accessory you use with it. Even low heat, if warmer than body temperature, can cause a burn, if the skin is exposed to the heat source for a long enough period of time.

● Handling



Avoid Magnetic Fields

Keep the computer away from magnets. Data stored on the hard disk may be lost.



Avoid Stacking

Do not place heavy objects on top of the computer.



Keep Small Objects Away

Do not insert paper clips or other small objects into the computer.



Do Not Disassemble the Computer

Do not attempt to disassemble your computer.



Avoid Excessive Force on the Display

Do not apply excessive downward force on the display when it is completely opened, especially when plugs and/or cables are connected to the rear of the computer.

Read Me First

● Peripherals

Incorrectly using peripheral devices may lead to a decrease in performance, an increase in temperature and/or damage your computer. For more information on peripheral devices, refer to the Reference Manual.

● Cables

Use of an interface cable longer than 3 m (9.84 feet) is not recommended.

Precautions (Battery Pack)

- Care should be exercised with regard to the following in order to avoid the possibility of overheating, fire or damage.



Avoid Heat

Do not throw the battery pack into a fire or expose it to excessive heat.



Keep Articles Away

Do not place the battery pack together with articles such as necklaces or hairpins when carrying or storing.



Do Not Disassemble

Do not insert sharp objects into the battery pack, expose it to bumps or shocks, deform, disassemble, or modify it.



Do Not Short

Do not short the positive (+) and negative (-) contacts.



Avoid Extreme Heat, Cold and Direct Sunlight

Do not charge, use or leave the battery pack for extended periods where it will be exposed to direct sunlight, in a hot place (in a car on a sunny day, for example), or in a cold place.



Do Not Use With Any Other Computer

The battery pack is rechargeable and was intended for the specified computer. Do not use it with a computer other than the one for which it was designed.



Do Not Put into a Microwave

Do not put the battery pack into a microwave oven or a pressurized chamber.



Stop Using

Should the battery emit an abnormal odor, become hot to the touch, become discolored, change shape, or become in any way different from normal, remove it from the computer and stop using it.

- Do not touch the terminals on the battery pack. The battery pack may no longer function properly if the contacts are dirty or damaged.
- Do not expose the battery pack to water, or allow it to become wet.

- If the battery pack will not be used for a long period of time (a month or more), charge or discharge (use) the battery pack until the remaining battery level becomes 30% to 40% and store it in a cool, dry place.
- This computer prevents overcharging of the battery by recharging only when the remaining power is less than approx. 95% of capacity.
- The battery pack is not charged when the computer is first purchased. Be sure to charge it before using it for the first time. When the AC adaptor is connected to the computer, charging begins automatically.
- Should the battery leak and the fluid get into your eyes, do not rub your eyes. Immediately flush your eyes with clear water and see a doctor for medical treatment as soon as possible.

NOTE

- The battery pack may become warm during recharging or normal use. This is completely normal.
- Recharging will not commence outside of the allowable temperature range (0 °C to 50 °C {32 °F to 131 °F}). (Reference Manual "Battery Power") Once the allowable range requirement is satisfied, charging begins automatically. Note that the recharging time varies based on the usage conditions. (Recharging takes longer than usual when the temperature is 10 °C {50 °F} or less.)
- If the temperature is low, the operating time is shortened. Only use the computer within the allowable temperature range.
- This computer has a high temperature mode function that prevents the degradation of the main battery in high temperature environments. If the high temperature mode is enabled in the Setup Utility (Reference Manual "Setup Utility"), a level of 100% in the [High Temperature] mode is about a level of 80% in the [Normal Temperature] mode.
- The battery pack is a consumable item. If the amount of time the computer can be run off a particular battery pack becomes dramatically shorter and repeated recharging does not restore its performance, the battery pack should be replaced with a new one.
- When transporting a spare battery inside a package, briefcase, etc., it is recommended that it be placed in a plastic bag so that its contacts are protected.
- Always power off the computer when it is not in use. Leaving the computer on when the AC adaptor is not connected will exhaust the remaining battery capacity.

Saving Data on the Hard Disk

- **Do not expose your computer to shock.**
Use care when handling your computer, shock may damage your hard disk or make your software applications and data unusable.
- **Do not power off your computer while software applications are running or hard disk drive indicator (LED) is on.**
Properly shut Windows* down to avoid problems.
- **Save all valuable data to disks.**
Backing up data to disks will limit damage should trouble occur to your computer or should you inadvertently change or erase data.
- **Use the security function for all important data.** (Reference Manual "Security Measures")

* **Windows 2000** : This computer uses Microsoft® Windows® 2000 Professional.

Windows XP : This computer uses Microsoft® Windows® XP Professional.

Hard-Disk-Lock

When the Hard Disk Lock is set to [Enable], it is impossible to read/write data from/to the hard disk when the hard disk is installed in a different computer, since a password is also set for the hard disk. When the hard disk is returned to the original computer, you can read/write data as before. In this case, however, make the settings in the Setup Utility exactly the same as they were before the hard disk was removed. (Note that this Hard Disk Lock does not guarantee the complete protection of data. (Reference Manual "Security Measures"))

When Using Peripheral Devices

Pay strict attention to the following points to avoid damage to the computer, peripheral devices, cables, etc. Also, in addition to following this manual and the Reference Manual, carefully read the instruction manuals for the peripheral devices being used.

- Use only peripheral devices that conform to the computer's specifications.
- Connect the devices properly, paying close attention to the condition and position of the connectors.
- If a connection cannot be made easily, do not apply undue force; check once more to confirm the condition and position of the connector (alignment of pins, etc.) .
- If the connector has holding screws, fasten the screws firmly.
- Do not carry the computer with cables attached, and do not pull on the cables forcefully.

When Disposing of or Transferring Ownership of This Device

When disposing of or transferring ownership of this device, erase all data on the hard disk in order to prevent the theft of hard disk data. Even if you delete data or initialize the hard disk through normal Windows commands, data can still be read using special software. In order to erase all data, either have the data erased by a specialist (at a charge) or use the hard disk data erase utility (included) (Reference Manual page 31). (Note that this hard disk data erase utility does not guarantee that data will be completely erased.)

Also, note that if you transfer ownership of this device without deleting commercial software that you have installed to the hard disk, you may be in violation of the licensing agreement for that software.

Computer Viruses

Users are advised to purchase the latest versions of virus protection software and use them regularly.

We recommend you run the software:

- After booting your computer.
- After receiving data.

We recommend that you check data received on disks or from external sources, such as data downloaded from the Internet, e-mail, etc. (For compressed files, uncompress them before running a check).

Read Me First

Wireless LAN

To prevent theft of data or unauthorized access to the hard disk via a wireless LAN
If you plan to use wireless LAN functions, we recommend that you do so only after making the appropriate security settings, such as for data encryption.

Usage Environment

● Environment

- Place the computer on a flat stable surface. Do not place the computer upright or allow it to tip over. When the computer receives extremely strong shock after falling, the hard disk may become inoperable.
- In use: Temperature: 5 °C to 35 °C {41 °F to 95 °F}
Humidity : 30% to 80% RH (No condensation)
- Not in use: Temperature: -20 °C to 60 °C {-4 °F to 140 °F}
Humidity : 30% to 90% RH (No condensation)

● Places not to use your computer

- Such areas may result in damage to the computer.
 - Areas with electronic equipment**
These areas may interfere with your display or cause your computer to produce strange sounds.
 - Areas with extremely high/low temperatures**
- Do not leave things near the computer that are sensitive to heat. During operation, the computer may become warm.

Handling

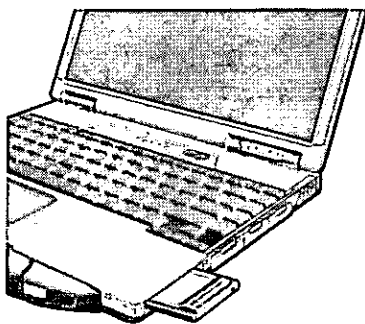

- Do not drop or hit your computer against solid objects.
- Do not carry your computer when it is on.
- Remove all external devices, cables, and PC Cards sticking out of the computer (see the figure on the left) before transporting the computer.
- We recommend preparing a fully charged battery.
When transporting a spare battery inside a package, briefcase, etc., it is recommended that it be placed in a plastic bag so that its contacts are protected.
- Do not carry the computer while the display is open, or carry it by gripping the display.
- Do not put anything (e.g., a piece of paper) between the display and keyboard.
- Always carry your computer with you. Never check it in with luggage. For use of the computer inside an aircraft, we recommend asking the airlines regarding their policy on this issue.
- It is a good idea to make backup copies on disks and carry them with you.
- Do not leave a disk in the drive while transporting your computer.

Maintenance

Touch Pad
→ page 19

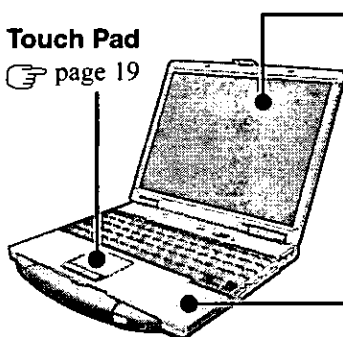

Display

Avoid using water when cleaning the panel. Ingredients included in water may leave scratches and reduce readability of the screen.

<When cleaning dust/dirt>

Avoid rubbing off dust/dirt with cloth since it may leave scratch on the screen.

Sweep dust/dirt with fine brush, then wipe it with a dry soft cloth used for cleaning glasses.

<When cleaning oily surface>

Apply camera lens cleaner on a soft gauze and clean it with gentle force. Then, wipe with a dry soft cloth used for cleaning glasses.

Areas excluding the display

Wipe these areas with a soft cloth, after applying water or detergent diluted with water to the soft cloth and firmly wringing out excess water.

CAUTION







- Do not use benzene, thinner, or rubbing alcohol. Doing so may adversely affect the surface, e.g., discoloration. In addition, do not use commercially-available household cleaners and cosmetics, as they may contain components harmful to the surface.
- Do not directly add or spray water or detergent. If liquid enters the inside of the computer, it may cause it to work improperly or be damaged.

First-time Operation

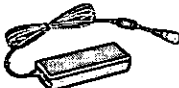
Read the steps below to help you learn what parts are included, and to gain an understanding of some basic computer-related operations.

1 Confirm the inclusion of all parts

Make sure the parts shown in the figure have been supplied. If any of these items are missing or is not working properly, contact Panasonic Technical Support.

AC Adaptor 1  Model No: CF-AA1653A	AC Cord 1 	Battery Pack 1  Model No: CF-VZSU26
Modem Telephone Cable 1 	Product Recovery CD-ROM  	
Operating Instructions (This book) ... 1	Windows Book 1	Win DVD™ CD-ROM (☞ page 32) 1

Getting Started

2 Read the LIMITED USE LICENSE AGREEMENT (☞ page 29)

Before removing the seal covering the power switch, read the LIMITED USE LICENSE AGREEMENT.

3 Turn the computer over and insert the battery pack

- ① Slide the right latch to the unlock position (🔓).
- ② Make sure the battery pack is facing the correct direction, slide it in the direction of the arrow.
- ③ Slide the right latch to the lock position (🔒), and then check to ensure that the battery pack is held firmly.
(Left latch is locked automatically.)

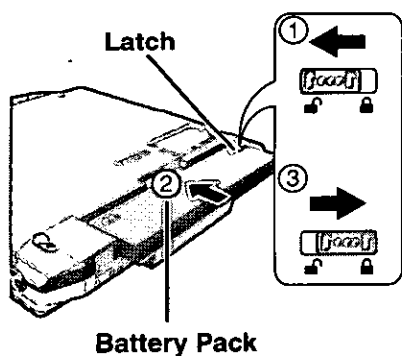

CAUTION

- Be sure the battery pack is properly connected to the connector.
- Do not touch the terminals on the battery pack and the computer. The battery pack may no longer function properly if the contacts are dirty or damaged. Also, the computer may not operate properly.
- Before using the battery pack, carefully read "Precautions (Battery Pack)" (☞ page 8).

First-time Operation

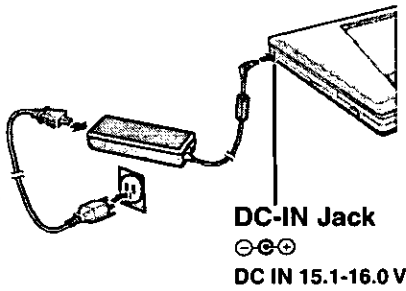

4 Connect your computer to a power outlet

The battery pack will be charged automatically.
Charging Time: Approx. 3 hours
(Varies depending on the usage conditions.)

CAUTION

- Be sure the AC adaptor is connected until completing Step 7.
- When using the computer for the first time, do not connect any peripheral device except the battery pack and AC adaptor to the computer.

Handling the AC adaptor

- Do not twist or pull the AC power cord forcefully. Doing so may damage the connections.
- Use only the specified AC adaptor with your computer. Using an AC adaptor other than the one supplied might damage the battery and/or the computer.
- When the DC plug is not connected to the computer, disconnect the AC cord from your AC wall outlet.
- Problems such as sudden voltage drops may arise during periods of thunder and lightning. Since this could adversely affect your computer, an uninterruptible power source (UPS) is highly recommended unless running from the battery pack alone.

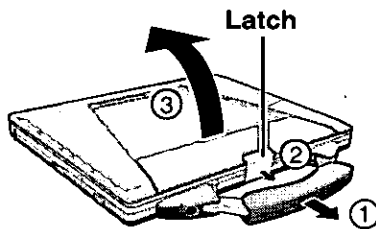

5 Open the display

- ① Pull the carrying handle forward.
- ② Lift up the latch.
- ③ Lift open the display.

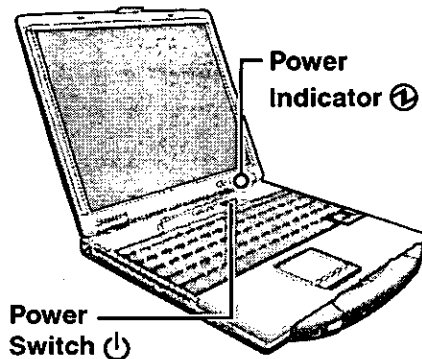

6 Turn your computer on

Press the power switch and hold it for approximately one second until the power indicator turns on before releasing it.

CAUTION

- Do not press the power switch and hold it for more than four seconds; this will cause the power to be turned off forcibly.
- Do not press the power switch repeatedly.
- Once the computer is powered off, you must wait at least ten seconds before powering it on again.

7 Setup Windows

Moving the cursor (⏏) or clicking buttons can be performed with the touch pad (☞ page 19).

Windows 2000

CAUTION

Do not press any key or move the touch pad until [Windows 2000 Professional Setup] is displayed.

- ① At the [Welcome to the Windows 2000 Setup Wizard], select [Next].
- ② After reading the agreement, select [I accept this agreement] or [I don't accept this agreement], then select [Next].

NOTE

If [I don't accept this agreement] is selected, the Windows setup will be aborted.

- ③ Select settings for your region, then select [Next].
- ④ Enter your name and organization and then select [Next].
- ⑤ Enter your computer name and administrator password and then select [Next].

CAUTION

Remember this password! If the password is forgotten, Windows cannot be operated.

- ⑥ Enter the correct date, time and the time zone, then select [Next].
You can also complete these settings at a later time. In this case, set [Date and Time] in [Start] - [Settings] - [Control Panel] - [Date/Time].
- ⑦ At [Networking Settings], select [Typical settings], then select [Next].
- ⑧ At [Workgroup or Computer Domain], select [No, this computer is not on a network, or is on a network without a domain], then select [Next].
The computer will restart.
- ⑨ At [Welcome to the Network Identification Wizard], select [Next].
- ⑩ At [Users of This Computer], select [Users must enter a user name and password to use this computer], then select [Next].
- ⑪ Select [Finish].
- ⑫ Enter your administrator password and select [OK].

Windows XP**CAUTION**

Do not press any key or move the touch pad until [Windows XP Professional Setup] is displayed.

- ① At [Welcome to the Windows XP Setup Wizard], select [Next].
- ② After reading the agreement, select [I accept this agreement] or [I don't accept this agreement], then select [Next].

NOTE

If [I don't accept this agreement] is selected, the Windows setup will be aborted.

- ③ Select settings for your region, then select [Next].
- ④ Enter your name and organization and then select [Next].
- ⑤ Enter your computer name and administrator password and then select [Next].

CAUTION

Remember this password! If the password is forgotten, Windows cannot be operated. You can create a password reset disk beforehand (➔ page 15).

- ⑥ Enter the correct date, time and the time zone, then select [Next].
You can also complete these settings at a later time. In this case, set [Date and Time] in [Start] - [Control Panel] - [Date, Time, Language, and Regional Options].
- ⑦ At [Networking Settings], select [Typical settings], then select [Next].
- ⑧ At [Workgroup or Computer Domain], select [No, this computer is not on a network, or is on a network without a domain], then select [Next].
The computer will restart.
- ⑨ Enter your administrator password and select .

NOTE

If [Windows XP is currently configured to manage the Intel(R) PRO/Wireless LAN adaptor.] is displayed, select [Yes].

This concludes the first-time use operation guidelines.

First-time Operation

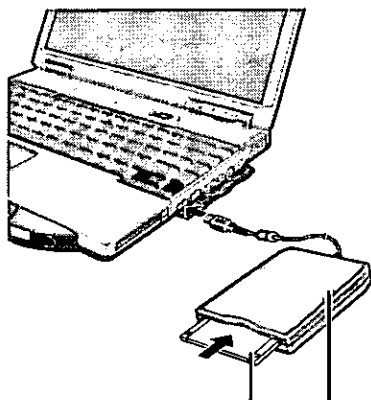

Label on the top surface, and insert the shutter-side headfirst.

USB Floppy Disk Drive

Create Backup Disks for Reinstallation

① **Windows 2000**

Select [Start] - [Programs] - [Panasonic] - [Create Backup Disk].

Windows XP

Select [Start] - [All Programs] - [Panasonic] - [Create Backup Disk].

When [You do not need to make "BACKUP DISK"] is displayed, there is no need to create a backup disk. If this message is not displayed, create backup disks for reinstallation.

To create backup disks, the USB floppy disk drive (optional: CF-VFDU03) and formatted 2HD floppy disks are needed.

② Connect the USB floppy disk drive to your computer.

NOTE

The floppy disk drive must be the A drive.

③ Prepare 2HD floppy disks and make sure they are not in the write-protected state, and then set it.

Follow the on-screen instructions.

④ Place a label identifying the contents on each disk.

● **Name of created backup disk**

FIRSTAID FD (When the display for creating the UPDATE FD is shown, create the disk by following the on-screen instructions.)

CAUTION

- Store the floppy disks in a safe place. They will enable you to return your computer to the condition at the time of purchase should any problems occur.
- When creating backup disks, do not run any other application program.
- When creating backup disks and the message [Insufficient files to copy] is displayed, select [OK] and then contact Panasonic Technical Support.
- While the floppy disk drive indicator is on, do not remove the floppy disk, power off your computer or use the standby or hibernation function (☞ Reference Manual "Standby/Hibernation Functions").
- <When [You do not need to make "BACKUP DISK"] is not displayed (procedure ① above)>

Be sure to create the backup disk.

If a backup disk is not created, it will be impossible to return the computer to its original state. In this case, contact Panasonic Technical Support.

Information for Windows XP

- Depending on the Windows settings, installed applications, and drivers, menus and other displays may differ, or some functions (such as use of the password reset disk) may be inoperable.
- You can select Classic view for the Control Panel or select the Classic Start menu. You can also change the way a user logs on or off. The procedure in this manual uses the method or view of the Windows XP default setting (not Classic view or Classic Start menu etc.).
- **Resetting the password**

Windows XP has a function to reset a forgotten password. To use this function, you need to create a password reset disk beforehand following the steps below.

 - 1 Connect the USB floppy disk drive (optional: CF-VFDU03) to your computer.
 - 2 Select [Start] - [Control Panel] - [User Accounts] and select the account you used to logon.
 - 3 Select [Prevent a forgotten password] from the [Related Tasks] menu and create a password reset disk following the on-screen instructions. Store the password reset disk in a safe place.
 - Only the logon password for each account can be reset.
 - The password set in the Setup Utility cannot be reset.
- When you create the first new account, you can only select [Computer administrator]. Only the added user account will be displayed in the Welcome screen. The account for the administrator created during Windows setup (when the computer is started up for the first time) will not be displayed.

Starting Up/Shutting Down

Starting Up

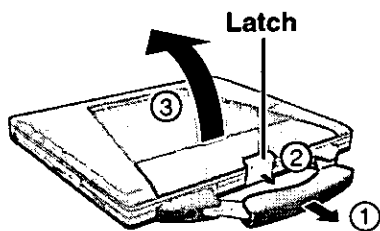

1 Open the display

- ① Pull the carrying handle forward.
- ② Lift up the latch.
- ③ Lift open the display.

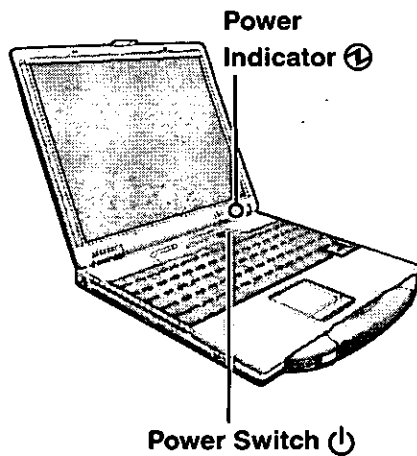

2 Turn your computer on

Press the power switch and hold it for approximately one second until the power indicator turns on before releasing it.

CAUTION

- While booting, avoid the following until the hard disk drive indicator () has turned off.
 - Connecting or disconnecting the AC adaptor.
 - Touching the power switch.
 - Performing any keyboard, touch pad or external mouse operations.
 - Closing the display.
- Once the computer is powered off, you must wait at least ten seconds before powering it on again.
- When the CPU temperature rises, the computer may not power on to prevent the CPU from overheating. Should this happen, allow the computer to cool down then switch the power on again.

If the computer still does not power on, contact Panasonic Technical Support.

NOTE

You may encounter the following situations when the computer is turned on at very low temperatures. These functions are designed to prevent hard disk drive malfunctions that may occur at low temperatures.

- The message "Warming up the system" is displayed, and start-up takes longer than usual (a few minutes or more).

In this case, wait for the computer to start up.
- The power indicator will blink quickly (in green); in this case, the power does not turn on, or the computer does not resume from standby or hibernation mode. To start the computer, leave it in an environment with a temperature of 5°C {41°F} or more for about an hour, and try turning the power on once more.

● **If [Enter Password] is displayed**

Enter your password* and press **(Enter)**. (☞ Reference Manual "Security Measures")

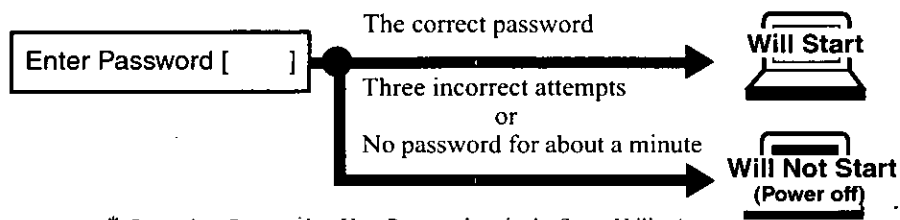

* Supervisor Password or User Password set in the Setup Utility (not the Windows password).

● **When an application or file that was previously displayed appears on your screen**



The standby or hibernation mode has been set (☞ Reference Manual "Standby/Hibernation Functions").

3 Log on to Windows

Windows 2000

After confirming that the hard disk drive indicator () has turned off, input the user name and password, then select [OK]. Until the correct user name and password are entered, the computer will not operate.

Windows XP

After confirming that the hard disk drive indicator () has turned off, select the user and input the password, then select . Until the correct password is entered, the computer will not operate.

4 Select your application

You are able to start working on your computer.

NOTE

- The power saving function is factory set, so if there is no input from a key, the touch pad or an external mouse (when one is connected) for a certain interval of time, the power to the LCD and hard disk may be turned off. The LCD will resume operation when the touch pad or an external mouse (when one is connected) is used or a key is pressed.
The power to the LCD may be turned off even when an application software is being installed. In this case, because it is conceivable that a selection dialog box will be shown, do not press **(Space)** or **(Enter)** to attempt to resume from this condition as doing so may trigger a selection, but instead, press a key unrelated to the direct triggering of a selection, like **(Ctrl)**.
In addition, when the computer is left alone, it automatically enters the standby or hibernation mode (☞ Reference Manual "Standby/Hibernation Functions"). The computer will resume by pressing the power switch.

Windows XP

- When switching to a different user with the Fast User Switching function, it may not be possible to set the settings of the display. In this case, log on with the administrator authority again, not using the Fast User Switching function, and try the operation once more.

Starting Up/Shutting Down

Shutting Down (power off your computer)

This procedure is for shutting down the computer without using the standby or hibernation function (☞ Reference Manual “Standby/Hibernation Functions”).

1 Save important data and close each application

2 **Windows 2000**
Select [Start] - [Shut Down]

Windows XP
Select [Start] - [Turn Off Computer]

3 **Windows 2000**
Select [Shut down], then select [OK]

Windows XP
Select [Turn Off]

Your computer will power off automatically.

● **Restarting your computer (without shutting down)**

Windows 2000
Select [Restart], then select [OK].

Windows XP
Select [Restart].

CAUTION





Do not do the following during the shutdown/restart procedure.

- Connecting or disconnecting the AC adaptor.
- Touching the power switch.
- Performing any keyboard, touch pad or external mouse operations.
- Closing the display.

NOTE

● **To shut down using the keyboard,**

Windows 2000

Press , **U**, and select [Shut down] with    , then press **Enter**.

Windows XP

Press , **U**, and select [Turn Off] with    , then press **Enter**.



● **To quickly resume computer operation after shutting down,**

The standby or hibernation function is available (☞ Reference Manual “Standby/Hibernation Functions”).

Touch Pad

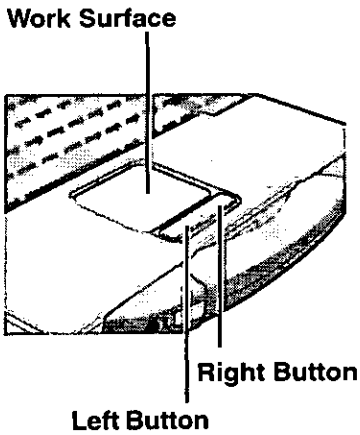
Use the touch pad to move the cursor on the display and perform normal computer operations.

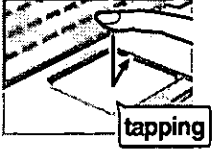
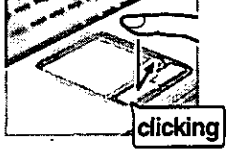
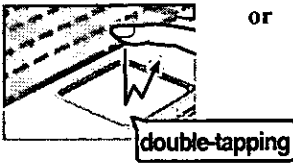
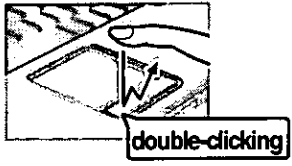
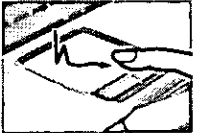

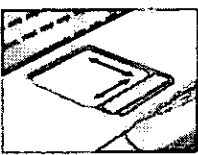
Function	Operation
Moving the Cursor	 <p>Move the tip of your finger lightly over the work surface.</p>
Tapping/Clicking	 tapping or  clicking
Double-Tapping/ Double-Clicking	 double-tapping or  double-clicking
Dragging	 or  <p>Two quick taps, but on the second tap leaving your finger down (applying pressure) and moving it on the work surface.</p> <p>While holding down the button, moving your finger on the work surface.</p>
Scroll Scroll a document (The movements will differ depending on the application.)	

Operation

NOTE

- Besides the above operations, operations such as Zoom and Pan are possible by allocating these functions to the buttons and/or pad. For more details, refer to [Mouse Properties]*.
 - * **Windows 2000** : Select [Start] - [Settings] - [Control Panel] - [Mouse].
 - * **Windows XP** : Select [Start] - [Control Panel] - [Printers and Other Hardware] - [Mouse].
- The operations of Scroll, Pan or Zoom will differ depending on the application. There are cases the touch pad will not support these operations even with an application that supports the functions.

Handling the Touch Pad

- The touch pad is designed to be used with a fingertip only. Therefore, avoid the following actions, which may cause damage to the work surface.
 - Placing any object on the work surface
 - Pressing down forcefully with sharp-pointed objects (e.g., nails) or hard objects that can leave marks (e.g., pencils and ball point pens)
- Try to avoid having any harmful substances such as oil, come in contact with the touch pad. The cursor may not work properly in such cases.
- **When the touch pad becomes dirty:**
Wipe to dirt by using a dry soft cloth such as gauze or a soft cloth first applied with detergent diluted with water and then thoroughly wrung.
Do not use benzene, thinner, or rubbing alcohol. Doing so may adversely affect the surface, e.g., discoloration. In addition, do not use commercially-available household cleaners and cosmetics, as they may contain components harmful to the surface.

Reference Manual

The Reference Manual and the Important Tips can be accessed on your computer. When a printer is connected, these manuals can also be printed.

- The Reference Manual explains functions for you to make greater use of the computer, such as how to add peripheral devices, how the Setup Utility works, and other useful information. (Refer to the cover of this manual for a list of the main contents included.)
- Important Tips provides information on how to maximize use of the battery pack, which is necessary for computing away from your home or office. It also offers helpful explanations on how to use the Touchscreen more effectively (only for models with touchscreen).

Running the Reference Manual or Important Tips

● Reference Manual

Windows 2000

Select [Reference Manual] in [Start] - [Programs] - [Panasonic] - [On-Line Manuals]

Windows XP

Select [Reference Manual] in [Start]

● Important Tips

Select  on the desktop

Important Tips can also be accessed from the following menu.

Windows 2000

Select [Important Tips] in [Start] - [Programs] - [Panasonic] - [On-Line Manuals]

Windows XP

Select [Important Tips] in [Start] - [All Programs] - [Panasonic] - [On-Line Manuals]

When the Reference Manual or Important Tips is started up for the first time, the License Agreement of the Acrobat Reader may be displayed. If it is displayed, after reading the agreement, select [Accept] to access the Reference Manual or Important Tips.

NOTE

- Illustrations may be difficult to view depending on the magnification. If the illustration is too small, magnify the display.
- The characters in PDF files (such as the Reference Manual) may be difficult to read depending on the Acrobat Reader settings and the Windows Desktop settings. In such cases, change the Acrobat Reader settings with the following procedure.
 - 1 Start up Acrobat Reader.
 - 2 Select [Edit] - [Preferences] - [Accessibility], and then set [Color Scheme] to [Use colors specified in document].
- When the taskbar is hidden at the bottom portion of Acrobat Reader, set the maximum display window size.
- If a printer is connected, we recommend printing pages. The illustrations and display samples may not print with a high quality.

Windows XP

- When switching to a different user with the Fast User Switching function, PDF files may not be printed properly. In this case, log on with the administrator authority again, not using the Fast User Switching function, and try the operation once more.

List of Error Codes

The following is a list of the messages that BIOS can display. Most of them occur during POST. Some of them display information about a hardware device, e.g., the amount of memory installed. Others may indicate a problem with a device, such as the way it has been configured. Following the list are explanations of the messages and remedies for reported problems.

If your system displays any of the below error messages other than the ones marked with an asterisk (*), write down the message and contact Panasonic Technical Support. If your system fails after you make changes in the Setup menus, reset the computer, enter Setup and install Setup defaults or correct the error.

0200 Failure Fixed Disk

Fixed disk is not working or not configured properly. Check to see if fixed disk is attached properly. Run Setup. Find out if the fixed-disk type is correctly identified.

0210 Stuck key

Stuck key on keyboard.

0211 Keyboard error

Keyboard not working.

0212 Keyboard Controller Failed

Keyboard controller failed test. May require replacing keyboard controller.

0213 Keyboard locked - Unlock key switch

Unlock the system to proceed.

0230 System RAM Failed at offset : *nnnn*

System RAM failed at offset *nnnn* of in the 64k block at which the error was detected.

0231 Shadow RAM Failed at offset : *nnnn*

Shadow RAM failed at offset *nnnn* of the 64k block at which the error was detected.

0232 Extended RAM Failed at offset : *nnnn*

Extended RAM Failed at address line : *nnnn*

Extended memory not working or not configured properly at offset or address *nnnn*.

0250 System battery is dead - Replace and run SETUP

The CMOS clock battery indicator shows the battery is dead. Replace the battery and run Setup to reconfigure the system.

***0251 System CMOS checksum bad - Default configuration used**

System CMOS has been corrupted or modified incorrectly, perhaps by an application program that changes data stored in CMOS. The BIOS installed Default SETUP Values. If you do not want these values, enter Setup and enter your own values. If the error persists, check the system battery or contact Panasonic Technical Support.

0260 System timer error

The timer test failed. Requires repair of system board.

0270 Real time clock error

Real-time clock fails BIOS test. May require board repair.

***0280 Previous boot incomplete - Default configuration used**

Previous POST did not complete successfully. POST loads default values and offers to run Setup. If the failure was caused by incorrect values and they are not corrected, the next boot will likely fail. On systems with control of wait states, improper Setup settings can also terminate POST and cause this error on the next boot. Run Setup and verify that the wait-state configuration is correct. This error is cleared the next time the system is booted.

0281 Memory Size found by POST differed from EISA CMOS

Memory size found by POST differed from EISA CMOS.

02B0 Diskette drive A error

02B1 Diskette drive B error

Drive A: or B: is present but fails the BIOS POST diskette tests. Check to see that the drive is defined with the proper diskette type in Setup and that the diskette drive is attached correctly.

02B2 Incorrect Drive A type - run SETUP

Type of floppy drive A: not correctly identified in Setup.

02B3 Incorrect Drive B type - run SETUP

Type of floppy drive B: not correctly identified in Setup.

02D0 System cache error - Cache disabled

Contact Panasonic Technical Support.

02F0: CPU ID:

CPU socket number for Multi-Processor error.

02F4: EISA CMOS not writable

ServerBIOS2 test error: Cannot write to EISA CMOS.

List of Error Codes

02F5: DMA Test Failed

ServerBIOS2 test error: Cannot write to extended DMA (Direct Memory Access) registers.

02F6: Software NMI Failed

ServerBIOS2 test error: Cannot generate software NMI (Non-Maskable Interrupt).

02F7: Fail - Safe Timer NMI Failed

ServerBIOS2 test error: Fail-Safe Timer takes too long.

***device* address Conflict**

Address conflict for specified *device*.

Allocation Error for: *device*

Run ISA or EISA Configuration Utility to resolve resource conflict for the specified *device*.

Failing Bits : *nnnn*

The hex number *nnnn* is a map of the bits at the RAM address which failed the memory test. Each 1 (one) in the map indicates a failed bit. See error 230,231 or 232 for offset address of the failure in System, Extended or Shadow memory.

Invalid System Configuration Data

Problem with NVRAM (CMOS) data.

I/O device IRQ conflict

I/O device IRQ conflict error.

Operating System not found

Operating system cannot be located on either drive A: or drive C:. Enter Setup and see if fixed disk and drive A: are properly identified.

Parity Check 1 *nnnn*

Parity error found in the system bus. BIOS attempts to locate the address and display it on the screen. If it cannot locate the address, it displays ????. Parity is a method for checking errors in binary data. A parity error indicates that some data has been corrupted.

Parity Check 2 *nnnn*

Parity error found in the I/O bus. BIOS attempts to locate the address and display it on the screen. If it cannot locate the address, it displays ????.

Press <F1> to resume, <F2> to Setup

Displayed after any recoverable error message. Press <F1> to start the boot process or <F2> to enter a Setup and change the settings. Write down and follow the information shown on the screen.

Dealing with Problems (Summary)

When a problem occurs, refer to this page. The "Reference Manual" also contains detailed information. If a problem appears to be related to a software application, read the software related manual. If you still cannot troubleshoot the problem, contact Panasonic Technical Support.

Starting Up

<p>The power indicator or battery indicator is not lit</p>	<ul style="list-style-type: none"> ● Check the cable connection for the AC adaptor. ● Check to see if a fully charged battery is properly inserted. ● Remove the battery pack and disconnect the AC adaptor, then connect them again.
<p>[Enter Password] is displayed</p>	<p>Input your password. If you have forgotten it, contact Panasonic Technical Support.</p>
<p>POST Startup Error(s) is displayed</p>	<p>☞ page 21</p>
<p>Windows startup, or an operation is extremely slow</p>	<p>Press (F9) in the Setup Utility (☞ <small>Reference Manual</small> "Setup Utility"). This will restore the Setup Utility's settings to their default values (except the password settings). Then, the Setup Utility must be run once again for you to input the appropriate operating environment settings. (The processing speed depends on the application software used, so this operation may not cause the processing speed to increase.)</p>
<p>The date and time are incorrect</p>	<ul style="list-style-type: none"> ● You can set the date and time using the following procedure: <ul style="list-style-type: none"> Windows 2000 [Control Panel] - [Date/Time] Windows XP [Control Panel] - [Date, Time, Language, and Regional Options] - [Date and Time] ● If you continue to experience problems, the internal battery maintaining the clock may need to be replaced. Contact Panasonic Technical Support. ● When the computer is connected to a LAN, confirm the date and time of the server. ● This computer will not correctly recognize the date and time starting from the year 2100 A.D.
<p>When resuming from the standby or hibernation mode, [Enter Password] does not appear even if a password has been set in the Setup Utility</p>	<p>Even when a password has been set in the Setup Utility, [Enter Password] does not appear when the computer resumes from the standby or hibernation mode. If you want to use the security function when using the standby or hibernation mode, use the Windows password as follows:</p> <ul style="list-style-type: none"> Windows 2000 Set the password in [Control Panel] - [Users and Passwords], then add the check mark for [Prompt for password when computer goes off standby] in [Control Panel] - [Power Options] - [Advanced]. Windows XP Select the account to change in [Control Panel] - [User Accounts] and set the password, then add the check mark for [Prompt for password when computer resumes from standby] in [Control Panel] - [Performance and Maintenance] - [Power Options] - [Advanced].
<p>When "Invalid system disk. Replace the disk, and then press any key." (or a similar message) is displayed</p>	<ul style="list-style-type: none"> ● This means a floppy disk that does not contain system startup information has been left in the floppy disk drive. Remove the floppy disk, and press any key. ● This message may appear when certain USB devices are connected. Remove the USB device, or set [Legacy USB support] in [Advanced] menu of the Setup Utility to [Disable]. ● If the message still appears even after trying the above two measures, this may be an indication that some type of hard disk failure has occurred. Contact Panasonic Technical Support.
<p>When the administrator password is forgotten</p>	<ul style="list-style-type: none"> Windows 2000 After reinstalling, setup Windows and then set the password again. Windows XP If you have created a password reset disk (☞ page 15), a message is displayed when you fail to correctly enter the password. Follow the message's instructions and set the password again by using the password reset disk. If you have not created a password reset disk, after reinstalling, setup Windows and then set the password again.

Dealing with Problems (Summary)

Starting Up (continued)

<p>When the previous item is not the cause</p>	<ul style="list-style-type: none"> ● Press (F9) in the Setup Utility (☞ <small>Reference Manual</small> "Setup Utility"). This will restore the Setup Utility's settings to their default values (except the password settings). ● Try removing all peripheral devices. ● Check a disk error using the following procedure. <ul style="list-style-type: none"> Windows 2000 1 Select [Local Disk(C:)] with the right button in [My Computer], and select [Properties]. 2 Select [Tools] - [Check Now]. 3 Select [Start] after selecting required items in [Check disk options]. Windows XP 1 Select [Local Disk(C:)] with the right button in [Start] - [My Computer], and select [Properties]. 2 Select [Tools] - [Check Now]. 3 Select [Start] after selecting required items in [Check disk options]. ● At startup, hold down (F8) when the [Panasonic] screen disappears, and release your finger when the Windows Advanced Options Menu is displayed. Start the computer in Safe Mode, and confirm the details of the error.
--	--

Display

<p>No display after powering on</p>	<ul style="list-style-type: none"> ● When there is no display to an external display, <ul style="list-style-type: none"> • Check your cable connection to the external display. • Confirm your display is powered on. • Check the settings for your external display. ● Try switching the display destination by pressing (Fn) + (F3).
<p>The power has not been turned off, but after a certain period of time, there is no display</p>	<ul style="list-style-type: none"> ● Has the computer been set to the power-saving mode? To resume operation of your computer from the condition the power of the display is off (for energy conservation purposes), press any key unrelated to the direct triggering of a selection, like (Ctrl). ● To save power, your computer may have automatically entered the standby mode (power indicator blinks green) or hibernation mode (power indicator turns off). In such cases, press the power switch. ● If you want to switch the display destination repeatedly by pressing (Fn) + (F3), make sure that the display destination has switched completely each time before pressing (Fn) + (F3) again.
<p>When the battery pack is used, the screen is darker than when the AC adaptor is connected</p>	<p>Press (Fn) + (F2) and adjust the brightness. Note, however, that when the brightness is increased, the battery running time will become shorter. Brightness can be set to separate levels for when the AC adaptor is connected and when it is disconnected.</p>
<p>The cursor cannot be controlled properly</p>	<ul style="list-style-type: none"> ● If you are using an external mouse, ensure that the external mouse has been connected correctly. ● Restart the computer by using the keyboard (Press (Windows), (U), and select [Restart] with (→) (←) (↑) (↓), then press (Enter)). ● If the computer does not respond to keyboard commands, read "Computer hangs" (☞ page 26).
<p>An afterimage appears (e.g., green, red, and blue dots remain on the display) or there are dots not displaying the correct colors</p>	<ul style="list-style-type: none"> ● If an image is displayed for a prolonged period of time, an afterimage may appear. This is not a malfunction. The afterimage will disappear when a different screen is displayed. ● High-precision and advanced technologies are necessary in the production of color liquid crystal displays (color LCDs). Therefore, if 0.002% or less of the picture elements either fail to light or remain constantly lit (that is, more than 99.998% of elements are functioning properly), no defect is considered to exist.
<p>The screen becomes disordered</p>	<ul style="list-style-type: none"> ● Changing the number of colors or resolution of the display may affect the screen. Restart the computer. Windows XP ● When using Extended Desktop, use the same display colors for the external display as those used by the LCD.

● **Display (continued)**

The external display no longer displays properly	When an external display not compatible with the power saving mode is used with the computer, the external display may no longer display properly when the computer enters the condition the power of the display is off (for energy conservation purposes). In such cases, turn off the power to the external display.
When the screensaver is set, an error will occur during a resume operation	When the computer automatically enters the standby or hibernation mode while the screensaver is running, an error may occur during a resume operation. In such cases, turn off the screensaver or try changing the pattern of the screensaver.
Windows XP An error occurs or the computer freezes while using Extended Desktop	If you use a 3D screen saver while in Extended Desktop mode at a high resolution, an error may occur or the computer may freeze. Under these conditions, do not use a 3D screen saver.

● **Shutting down**

Windows cannot be shut down or restarted	If a USB device is connected, try removing it.
“This program is not responding” is displayed when shutting down or logging off.	This message appears periodically; for example, when using a Wireless LAN. If the message appears, select [End Now]. Delete the check mark for [Show the tray icon] in the following menu. Windows 2000 [Start] - [Programs] - [Intel Network Adapters] - [Intel(R) PROSet] Windows XP [Start] - [Programs] - [Intel Network Adapters] - [Intel(R) PROSet]

● **Battery Indicator**

The red indicator lights	The battery level is very low (the charge is less than approx. 9% capacity). Connect the AC adaptor. You can use the computer when the indicator light is orange. If you do not have an AC adaptor, save your data and power off your computer. After replacing the battery pack with a fully charged one, turn your computer on.
The red indicator blinks	Quickly save your data and power off your computer. Remove the battery pack and disconnect the AC adaptor, then connect them again. If the problem persists, contact Panasonic Technical Support. The battery pack or recharging function may be defective.
The orange indicator blinks	Battery cannot be recharged temporarily because the internal temperature of the battery pack is outside of the acceptable temperature range for recharging. Once the allowable range requirement is satisfied, charging begins automatically. Your computer can be used normally.

● **Reference Manual**

The Reference Manual is not displayed	Is Acrobat Reader installed? If Acrobat Reader is not installed, run [c:\util\reader\ar505enu.exe] in [Start] - [Run] to reinstall the program. When installing the program, do not change the installation destination folder. If the destination folder is changed, the Reference Manual cannot be opened from the [Start] menu.
--	---

Dealing with Problems (Summary)

● Fast User Switching Function **Windows XP**

Some applications do not work properly	<p>When switching to a different user with the Fast User Switching function, the following problems may occur.</p> <ul style="list-style-type: none">• Some applications may not work properly (for example, PDF files may not be printed properly).• It may not be possible to set the settings of the display.• A serial mouse may not work.• Wireless LAN may not work. <p>If any of the above occur, log on with the administrator authority again, not using the Fast User Switching function, and try the operation once more.</p>
---	---

● Others

Computer hangs	<ul style="list-style-type: none">● Press Ctrl + Shift + Esc to open Task Manager and close the software application which is not responding.● After shutting down by pressing the power switch for more than four seconds, press the power switch to power on and open the application again. If the program no longer works normally, delete the program using the following procedure. Then reinstall the program. Windows 2000 : [Start] - [Settings] - [Control Panel] - [Add/Remove Programs] Windows XP : [Start] - [Control Panel] - [Add or Remove Programs]
-----------------------	---

Reinstalling Software

When reinstall procedure is performed, the contents of the hard disk will be erased. Be sure to back up any critical data that is on your hard disk before running the reinstall procedure.

The reinstall procedure will return the computer to its original condition.

- If you have created partitions for data, the data may be erased or become corrupt as a result of the reinstall procedure.

Before Reinstallation

● Preparing

- You will need the followings:
 - Product Recovery CD-ROM and CD drive
 - If it was necessary to create backup disks ("Create Backup Disks for Reinstallation" on page 14), you will need the backup disks (e.g., FIRST AID FD) and the floppy disk drive.
- The operation of reinstallation takes about 20 - 30 minutes.

● Important

- Before the reinstallation procedure, remove all peripherals (except for the CD drive).
- Be sure the AC adaptor is connected until the reinstallation procedure is completed.

Reinstalling

- 1 Turn the computer off and set the CD drive in the multi-media pocket.
- 2 Turn the computer on, and immediately hold down **(F2)**. Release the key when the Setup Utility starts up. If the password has been set, enter the Supervisor Password.
- 3 Write down all of the contents of the Setup Utility and then press **(F9)**. At the confirmation message, select [Yes] and then press **(Enter)**.
- 4 Select [Boot] menu, then select [CD Drive] and press **(F6)** until [CD Drive] is at the top of the [Boot] menu.
- 5 Place the disc number one of the recovery CDs into the CD drive.
- 6 Press **(F10)**. At the confirmation message, select [Yes] and press **(Enter)**. The computer will restart, and this screen should appear.

```
-----  
Select a number  
-----  
1. Start restoring the operating system.  
2. Erase the whole data on HDD for security.  
3. End  
-----
```

- 7 Select [1. Start restoring the operating system.]. The License Agreement screen should appear.

- 8 Select [1. Yes, I agree to the provisions above and wish to continue!].

This screen should appear.

Windows 2000

```
-----  
Select a number  
-----  
1. Restore Windows(R) 2000 Professional to the whole HDD.  
2. Make two partitions, for the operating system and data. And restore  
Windows(R) 2000 Professional to the operating system partition.  
(All existing partitions on HDD will be lost.)  
3. Restore Windows(R) 2000 Professional to the first partition.  
4. End  
-----
```

Windows XP

```
-----  
Select a number  
-----  
1. Restore Windows(R) XP Professional to the whole HDD.  
2. Make two partitions, for the operating system and data. And restore  
Windows(R) XP Professional to the operating system partition.  
(All existing partitions on HDD will be lost.)  
3. Restore Windows(R) XP Professional to the first partition.  
4. End  
-----
```

- 9 Make a selection from the menu.
 - When selecting [2], enter the basic partition size for the operating system installation and press **(Enter)**. (The data partition size is the remainder after subtracting the basic partition size.)
 - To select [3], the initial partition size must be 6 GB or more of the hard disk size. Reinstallation cannot be performed with a small partition size.

Reinstalling Software

- 10 At the confirmation message, press **Y**.
The operation of reinstallation for the hard disk starts automatically. (The operations take about 15 minutes.)

CAUTION

- Do not cancel the reinstall procedure before it is completed.
- When a message appears instructing you to insert the next CD, insert the recovery CD showing the next number in the sequence, and then select [OK]. If the message "The media does not contain the correct file" appears, select [OK]. A message will appear instructing you to insert the next CD. Confirm that the proper recovery CD has been inserted by opening the tray of the CD drive and then close the tray, then select [OK].

- 11 After the reinstallation procedure completes, the following message will appear on the display.
Remove the recovery CD.

Windows 2000

Windows(R) 2000 Professional install wizard will start after reboot.
Remove the Product Recovery CD-ROM, then restart the computer by pressing Ctrl + Alt + Del (Delete).

Windows XP

Windows(R) XP Professional install wizard will start after reboot.
Remove the Product Recovery CD-ROM, then restart the computer by pressing Ctrl + Alt + Del (Delete).

- 12 Restart the computer by pressing **Ctrl** + **Alt** + **Del** and immediately hold down **F2**. Release the key when the Setup Utility starts up.
If the password has been set, enter the Supervisor Password.

- 13 Press **F9**.

At the confirmation message, select [Yes] and then press **Enter**. (The Setup Utility settings will return to their default values. Even the security settings with the exception of the password(s) will return to their default values.)

- 14 Press **F10**.

At the confirmation message, select [Yes] and press **Enter**.

- 15 Perform the setup procedure for Windows by following the instructions on the screen.

Windows 2000  Page 12

Windows XP  Page 13

- 16 Run the Setup Utility and change the settings where necessary.

NOTE

When the FIRTAID FD is to be created, follow the steps in the readme.txt on the disk. ( page 14)

<Changing the drive letter>

You can change the drive letter for the CD drive or hard disk drive by the following steps.

- Drive letters can only be changed when two or more partitions have been created on the hard disk drive. The name of the C: drive cannot be changed.
- We recommend that you make these changes before installing applications.

Windows 2000

- 1 Select [Start] - [Settings] - [Control Panel] - [Administrative Tools] - [Computer Management].
- 2 Select [Disk Management] from [Storage].
- 3 Right click on the partition of the hard disk or the name of the CD drive and select [Change Drive Letter and Path...].
- 4 Select [Edit].
- 5 Select [Assign a drive letter] and select the new drive letter, and then select [OK].
- 6 At the confirmation message, select [Yes].

Windows XP

- 1 Select [Start] - [Control Panel] - [Performance and Maintenance] - [Administrative Tools] - [Computer Management].
- 2 Select [Disk Management] from [Storage].
- 3 Right click on the partition of the hard disk or the name of the CD drive and select [Change Drive Letter and Paths...].
- 4 Select [Change].
- 5 Select [Assign the following drive letter] and select the new drive letter, and then select [OK].
- 6 At the confirmation message, select [Yes].

LIMITED USE LICENSE AGREEMENT

THE SOFTWARE PROGRAM(S) ("PROGRAMS") FURNISHED WITH THIS PANASONIC® PRODUCT ("PRODUCT") ARE LICENSED ONLY TO THE END-USER ("YOU"), AND MAY BE USED BY YOU ONLY IN ACCORDANCE WITH THE LICENSE TERMS DESCRIBED BELOW. YOUR USE OF THE PROGRAMS SHALL BE CONCLUSIVELY DEEMED TO CONSTITUTE YOUR ACCEPTANCE OF THE TERMS OF THIS LICENSE.

Matsushita Electric Industrial Co., Ltd. ("MEI") has developed or otherwise obtained the Programs and hereby licenses their use to you. You assume sole responsibility for the selection of the Product (including the associated Programs) to achieve your intended results, and for the installation, use and results obtained therefrom.

LICENSE

- A. MEI hereby grants you a personal, non-transferable and non-exclusive right and license to use the Programs in accordance with the terms and conditions stated in this Agreement. You acknowledge that you are receiving only a LIMITED LICENSE TO USE the Programs and related documentation and that you shall obtain no title, ownership nor any other rights in or to the Programs and related documentation nor in or to the algorithms, concepts, designs and ideas represented by or incorporated in the Programs and related documentation, all of which title, ownership and rights shall remain with MEI or its suppliers.
- B. You may use the Programs only on the single Product which was accompanied by the Programs.
- C. You and your employees and agents are required to protect the confidentiality of the Programs. You may not distribute or otherwise make the Programs or related documentation available to any third party, by time-sharing or otherwise, without the prior written consent of MEI.
- D. You may not copy or reproduce, or permit to be copied or reproduced, the Programs or related documentation for any purpose, except that you may make one (1) copy of the Programs for backup purposes only in support of your use of the Programs on the single Product which was accompanied by the Programs. You shall not modify, or attempt to modify, the Programs.
- E. You may transfer the Programs and license them to another party only in connection with your transfer of the single Product which was accompanied by the Programs to such other party. At the time of such a transfer, you must also transfer all copies, whether in printed or machine readable form, of every Program, and the related documentation, to the same party or destroy any such copies not so transferred.
- F. You may not remove any copyright, trademark or other notice or product identification from the Programs and you must reproduce and include any such notice or product identification on any copy of any Program.

YOU MAY NOT REVERSE ASSEMBLE, REVERSE COMPILE, OR MECHANICALLY OR ELECTRONICALLY TRACE THE PROGRAMS, OR ANY COPY THEREOF, IN WHOLE OR IN PART.

YOU MAY NOT USE, COPY, MODIFY, ALTER, OR TRANSFER THE PROGRAMS OR ANY COPY THEREOF, IN WHOLE OR IN PART, EXCEPT AS EXPRESSLY PROVIDED IN THE LICENSE.

IF YOU TRANSFER POSSESSION OF ANY COPY OF ANY PROGRAM TO ANOTHER PARTY, EXCEPT AS PERMITTED IN PARAGRAPH E ABOVE, YOUR LICENSE IS AUTOMATICALLY TERMINATED.

TERM

This license is effective only for so long as you own or lease the Product, unless earlier terminated. You may terminate this license at any time by destroying, at your expense, the Programs and related documentation together with all copies thereof in any form. This license will also terminate effective immediately upon occurrence of the conditions therefor set forth elsewhere in this Agreement, or if you fail to comply with any term or condition contained herein. Upon any such termination, you agree to destroy, at your expense, the Programs and related documentation together with all copies thereof in any form.

YOU ACKNOWLEDGE THAT YOU HAVE READ THIS AGREEMENT, UNDERSTAND IT AND AGREE TO BE BOUND BY ITS TERMS AND CONDITIONS. YOU FURTHER AGREE THAT IT IS THE COMPLETE AND EXCLUSIVE STATEMENT OF THE AGREEMENT BETWEEN US, WHICH SUPERSEDES ANY PROPOSAL OR PRIOR AGREEMENT, ORAL OR WRITTEN, AND ANY OTHER COMMUNICATIONS BETWEEN US, RELATING TO THE SUBJECT MATTER OF THIS AGREEMENT.

Contrat de licence d'usage limité

Le(s) logiciel(s) (les "Logiciels") fournis avec ce produit Panasonic® (le "Produit") sont exclusivement concédés en licence à l'utilisateur ultime ("vous"), et ils ne peuvent être utilisés que conformément aux clauses contractuelles ci-dessous. En utilisant les logiciels, vous vous engagez de manière définitive à respecter les termes, clauses et conditions des présentes.

Matsushita Electric Industrial Co., Ltd. ("MEI") a mis au point ou obtenu les Logiciels et vous en concède l'utilisation par les présentes. Vous assumez l'entière responsabilité du choix de ce Produit (y compris des Logiciels associés) pour obtenir les résultats escomptés, ainsi que de l'installation, de l'utilisation et des résultats obtenus.

Licence

- A. MEI vous octroie par les présentes le droit et la licence personnels, non cessibles et non exclusifs d'utiliser les Logiciels conformément aux termes, clauses et conditions de ce Contrat. Vous reconnaissez ne recevoir qu'un droit limité d'utiliser les Logiciels et la documentation les accompagnant et vous vous engagez à n'obtenir aucun droit de titre, propriété ni aucun autre droit vis-à-vis des Logiciels et de la documentation les accompagnant ni vis-à-vis des algorithmes, concepts, dessins, configurations et idées représentés par ou incorporés dans les Logiciels et la documentation les accompagnant, dont les titres, propriété et droits resteront tous à MEI ou à leurs propriétaires.
- B. Vous ne pouvez utiliser les Logiciels que sur le Produit unique qui est accompagné par les Logiciels.
- C. Vous et vos employés ou agents êtes requis de protéger la confidentialité des Logiciels. Vous ne pouvez ni distribuer ni mettre les Logiciels et la documentation les accompagnant à la disposition d'un tiers, par partage de temps ou de quelque autre manière que ce soit, sans l'autorisation écrite préalable de MEI.
- D. Vous ne pouvez ni copier ni reproduire ni permettre la copie ni la reproduction des Logiciels ni de la documentation les accompagnant pour quelque fin que ce soit, à l'exception d'une (1) copie des Logiciels à des fins de sauvegarde uniquement pour soutenir votre utilisation des Logiciels sur le Produit unique qui est accompagné par les Logiciels. Vous ne pouvez ni modifier ni tenter de modifier les Logiciels.
- E. Vous ne pouvez céder les Logiciels et en octroyer la licence à une autre partie qu'en rapport avec votre cession du Produit unique qui est accompagné par les Logiciels à cette autre partie. Au moment de cette cession, vous devez céder également toutes les copies, que ce soit sous forme imprimée ou lisible par la machine, de tous les Logiciels ainsi que de la documentation les accompagnant, à la même partie ou détruire les copies non cédées.
- F. Vous ne pouvez retirer aucune marque de droits d'auteur, marque ou autre ni aucune identification de produit des Logiciels et vous devez reproduire et inclure toutes ces notices ou identifications de produit sur toutes les copies des Logiciels.

Vous ne pouvez assembler en sens inverse, compiler en sens inverse ni retracer les Logiciels ni aucune de leurs copies, de façon électronique ou mécanique, en tout ou en partie.

Vous ne pouvez utiliser, copier, modifier, altérer ni céder les Logiciels ni aucune de leurs copies, en tout ou en partie, à l'exception de ce qui est expressément stipulé dans ce contrat.

Si vous cédez la possession de toute copie ou de tout Logiciel à une autre partie, à l'exception de ce qui est autorisé au paragraphe E ci-dessus, votre licence est automatiquement résiliée.

Termes, clauses et conditions

Cette licence n'est effective que pour la durée de possession ou de crédit-bail du Produit, à moins d'une résiliation antérieure. Vous pouvez résilier cette licence à tout moment en détruisant, à vos frais, les Logiciels et la documentation les accompagnant avec toutes leurs copies, sous quelque forme que ce soit. Cette licence sera également résiliée, avec application immédiate, si les conditions de résiliation définies ailleurs dans ce contrat se sont réalisées ou si vous ne respectez pas les termes, clauses et conditions qui y sont contenues. Au moment de la résiliation, vous acceptez de détruire, à vos frais, les Logiciels et la documentation les accompagnant avec toutes leurs copies, sous quelque forme que ce soit.

Vous reconnaissez avoir lu ce contrat, en avoir compris toute la substance et avoir accepté de respecter ses termes, clauses et conditions. Vous reconnaissez en outre qu'ils sont la description complète et exclusive du contrat conclu entre nous, contrat qui remplace et annule toute proposition ou contrat précédent, écrit ou oral, et toute autre communication entre nous, relativement à l'objet du présent contrat.

Hard Disk Data Erase Utility

This computer is equipped with a utility for erasing hard disk data.

When disposing of or transferring ownership of this device, erase all data on the hard disk in order to prevent the theft of hard disk data following the steps below.

The hard disk data erase utility erases data using an "overwriting" method, but there is a possibility that due to malfunctions or other operational errors, data may not be completely erased. There are also specialized devices that may be able to read data that has been erased using this method. If you need to erase highly confidential data, we recommend that you contact a company that specializes in this process. Matsushita Electric Industrial Co., Ltd. will bear no responsibility for losses or damages suffered as a result of the use of this utility.

Preparing

You will need the Product Recovery CD-ROM and CD drive.

NOTE

- Be sure the AC adaptor is connected until the procedure is completed.
- This utility can only be used for internal hard disk. It cannot be used to erase data from external hard disks.
- This utility cannot erase data from damaged disk.
- This utility cannot erase data for specific partitions.
- After executing this utility, the computer cannot be booted from the hard disk.

Procedure

- 1 Turn the computer off and set the CD drive in the multimedia pocket.
- 2 Turn the computer on, and immediately hold down **(F2)**. Release the key when the Setup Utility starts up. If the password has been set, enter the Supervisor Password.
- 3 Select [Boot] menu, then select [CD Drive] and press **(F6)** until [CD Drive] is at the top of the [Boot] menu.
- 4 Place disc number one of the recovery CDs into the CD drive.
- 5 Press **(F10)**.
At the confirmation message, select [Yes] and press **(Enter)**.
The computer will reboot, and this screen should appear.

```
-----  
Select a number  
-----  
1. Start restoring the operating system.  
2. Erase the whole data on HDD for security.  
3. End  
-----
```
- 6 Select [2. Erase the whole data on HDD for security.].
- 7 At the confirmation message, press **(Y)**.
- 8 At [<<(Enter).
- 9 The time required for erasing data will be displayed.
Press **(Space)**.
- 10 At the confirmation message, press **(Enter)**.
The operation of erasing the hard disk starts.
- 11 After the operation is complete:
Under normal conditions, the message [Hard disk data has been deleted.] will be displayed.
If a problem occurred during the operation, an error message will be displayed.
- 12 Remove the recovery CD, then turn off the computer by using the power switch.

WinDVD™ (hereafter, WinDVD) is a software application for DVD playback. Here, you will find explanations and general information on the installation procedure and how to access the online manual.

Installing WinDVD

CAUTION

- Close all other software application before running the Setup program for WinDVD for added safety.
- Log on as the administrator.

- ① Set the WinDVD CD-ROM in the CD drive.
The WinDVD setup program will run automatically (allow some time for disc recognition). When the setup program will not run automatically, input [x:\setup] in [Start] - [Run] and select [OK]. ("x" is the drive letter. You can change the letter to suit your preference.)
- ② Select [Next] at the Welcome Message.
- ③ After reading the "License Agreement", select [Yes] if you agree to the terms.
* Refer to the "LIMITED USE LICENSE AGREEMENT" (☞ page 29)
- ④ Follow the on-screen instructions and install WinDVD.

<Confirmation of the DVD-ROM drive settings>

To run WinDVD, it is necessary to make the following settings.

- ① **Windows 2000** Select [Start] - [Settings] - [Control Panel] - [System] - [Hardware] - [Device Manager].
Windows XP Select [Start] - [Control Panel] - [Performance and Maintenance] - [System] - [Hardware] - [Device Manager].
- ② Double-click [Primary IDE Channel] for [IDE ATA/ATAPI controllers].
- ③ Select [Advanced Settings], and confirm that [Transfer Mode] is set to [DMA if available] for [Device 0].
- ④ Double-click [Secondary IDE Channel] for [IDE ATA/ATAPI controllers] and perform as the step ③.

Running WinDVD

Windows 2000

Select [Start] - [Programs] - [InterVideo WinDVD] - [InterVideo WinDVD] or select  on the desktop.

Windows XP

Select [Start] - [All Programs] - [InterVideo WinDVD] - [InterVideo WinDVD] or select  on the desktop.

<How to access the online manual>

Select "?" of the WinDVD control panel.

NOTE

- Do not enter the standby or hibernation mode while WinDVD is running.
- Do not start WinDVD while the hard disk drive indicator is blinking immediately after the computer was started up.
- If you maximize the video display window, you can return to the original window size by double-clicking over the images.
- During video playback (while the access lamp is on), do not eject the disc.
- Do not use other applications or the Command Prompt, and do not change the settings of the screen properties.
- In some cases, when the number of colors for the display is increased, a message appears and the DVD cannot be played. If this happens, reduce the number of display colors.
- Immediately after resuming from a pause, frame dropping may occur depending on the operating environment or DVD video (images or sounds are disrupted).
- In the Extended Desktop (Dualview) or simultaneous (internal/external) display mode, there are times when images or video are not displayed correctly.
- During a prolonged period of rapid advance, the pause mode may be established at some point. If this happens, exit WinDVD, and restart.

About Regions Setting

The DVD-Video has a region code that is fixed according to the region where it is sold. In order to play a DVD-Video, the region code of the player software and of the drive must match that of the DVD-Video.

<Example>

For U.S.A. and Canada: "1"

For Europe: "2"

The region code is not set prior to the shipment of this drive. Therefore, operations will differ depending on the first DVD-Video played.

- In the case of a DVD-Video with a specific region code:

The drive will automatically be set with the same region code as the DVD-Video.

- In the case of any other DVD-Video:

[Confirm Region] appears. Select region code and select [OK]. Play now begins.

([Confirm Region] may not be displayed for some DVD-Videos. To confirm the current region code and the number of settings remaining, right-click on the WinDVD screen and select [Setup]-[Region].)

NOTE

[Confirm Region] will also be displayed if a DVD-Video with one region code is inserted into a drive for which another region code has already been set.

CAUTION

The region code can be set a total of five times, including the initial setting. Proceed very carefully, because after the fourth change has been made, the region code set last is fixed and no further changes can be made.

The user must take responsibility for any trouble that results from illegally changing or altering the region code.

Information

Inquires about WinDVD should be made to InterVideo, Inc.

InterVideo, Inc.

URL: <http://www.intervideo.com/>

E-mail: support@intervideo.com

Names and Functions of Parts

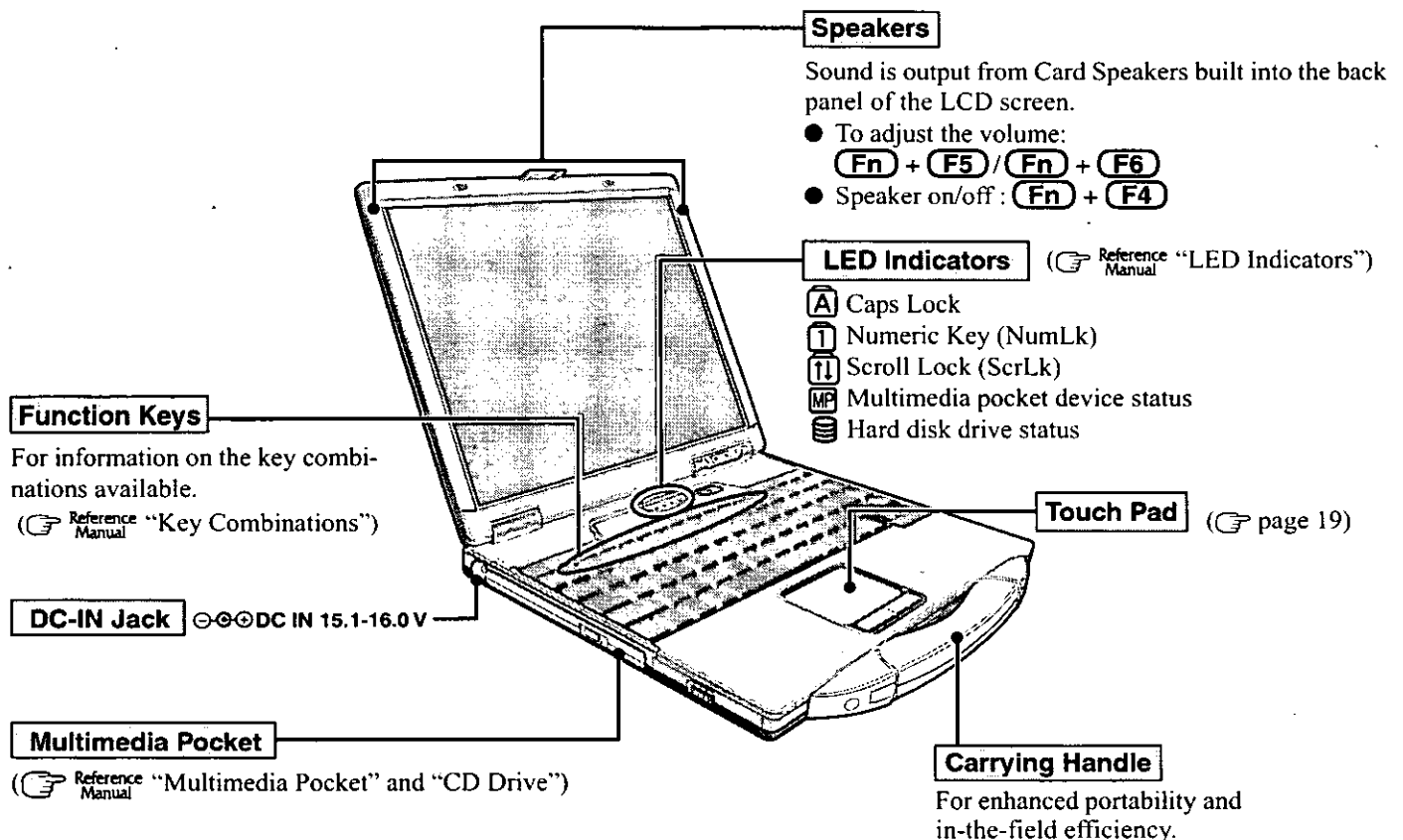
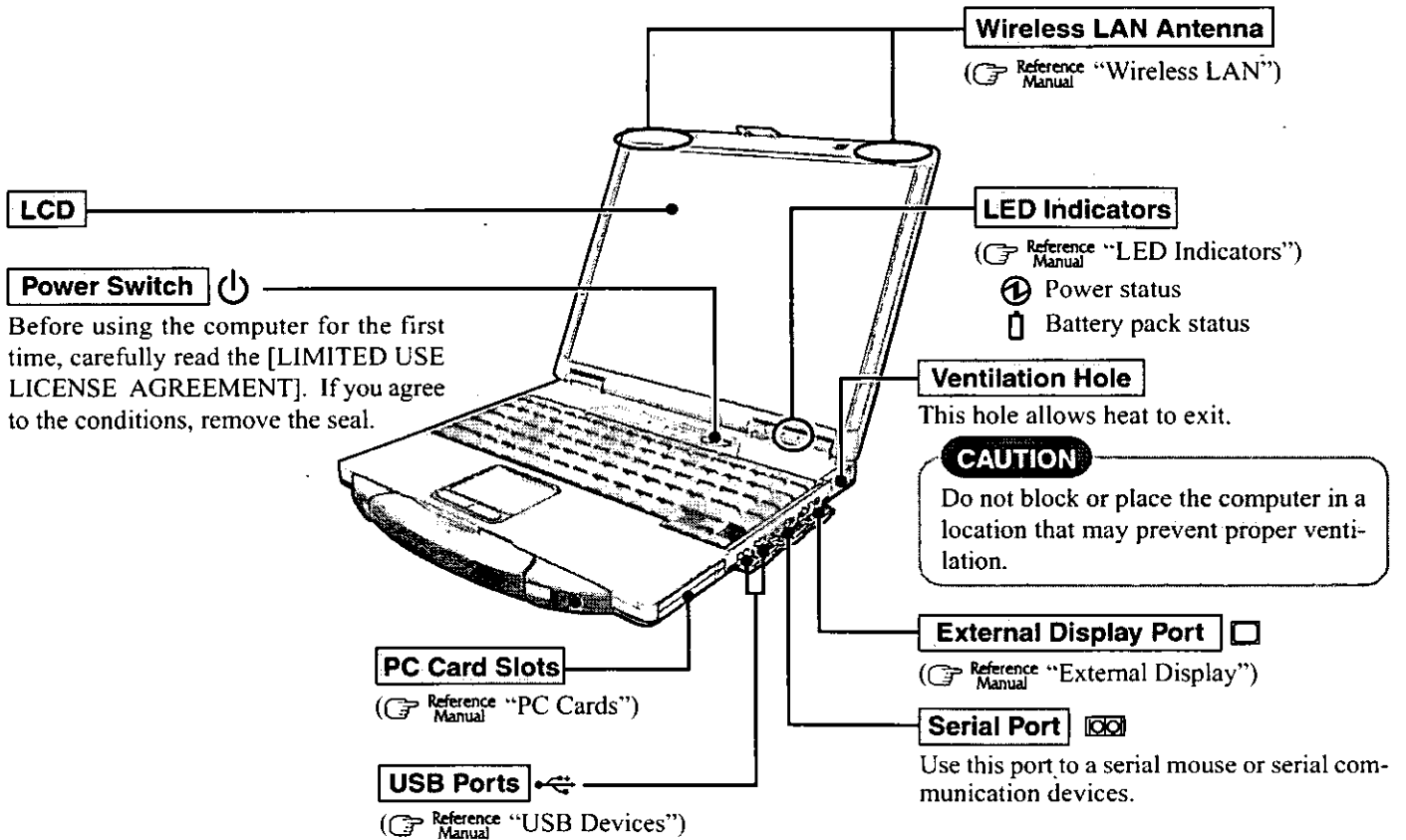

Modem   Reference Manual "Modem"

I/O Box Connector

For connecting printer, external mouse, keyboard, etc., through the I/O box (optional).

Ventilation Hole

This hole allows heat to exit.

CAUTION

Do not block or place the computer in a location that may prevent proper ventilation.

LAN   Reference Manual "LAN"

Headphone Jack 

Use this jack to connect headphones or amplifier-equipped speakers. Audio output from the internal speaker is disabled when headphones or external speakers are connected.

Microphone Jack 

Use only a monaural condenser microphone (miniature jack). Using an input source other than a monaural condenser microphone may not allow audio to be input or may damage the equipment.

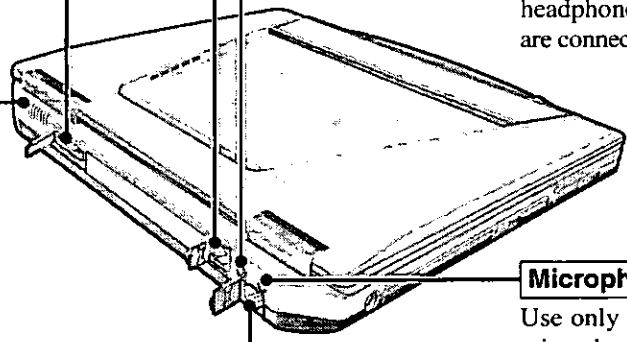

MP Release Button

 Reference Manual "Multimedia Pocket")

Expansion Bus Connector



 Reference Manual "Port Replicator")

RAM Module Slot

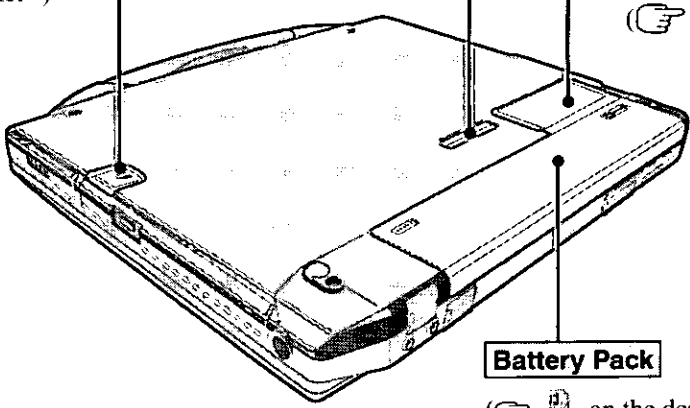
 Reference Manual "RAM Module")



Battery Pack

  on the desktop, Reference Manual "Battery Power")



A lithium ion battery that is recyclable powers the product you have purchased. Please call 1-800-8-BATTERY for information on how to recycle this battery.

L'appareil que vous vous êtes procuré est alimenté par une batterie au lithium-ion. Pour des renseignements sur le recyclage de la batterie, veuillez composer le 1-800-8-BATTERY.

Specifications

● Main Specifications

Model No.		CF-73E3KVXDM	CF-73E3KVXKM
CPU		Intel® Pentium M processor 1,400 MHz L2 (Second) Cache Memory: 1 MB	
Memory (Expandable to)		256 MB (768 MB Max.)	
Video Memory		32 MB	
LCD	Type	13.3 type (TFT)	
	Displayed Colors*1	256/65536/16M colors (640 x 480 dots/800 x 600 dots/1024 x 768 dots)	
External Display		256/65536/16M colors (640 x 480 dots/800 x 600 dots/1024 x 768 dots/1280 x 1024 dots/1600 x 1200 dots/2048 x 1536 dots)*2	
Hard Disk Drive		40GB*3	
Keyboard		87 keys	
DVD-ROM Drive		DVD-ROM read: 8x speed (Max.) CD-ROM read: 24x speed (Max.)	
Slots	PC Card Slots	Two Type I or Type II, or one Type III	
	Allowable current (total for two slots)	3.3 V: 400 mA 5 V: 400 mA	
	RAM Module Slot*4	200-pin, SO-DIMM, DDR-SDRAM, PC2100 Compliant	
Interface	External Display Port	Mini Dsub 15-pin female	
	Serial Port	Dsub 9-pin male	
	Microphone Jack*5	Miniature jack, 3.5 DIA	
	Headphone Jack	Miniature jack, 3.5 DIA Impedance 32 Ω, Output Power 4 mW x 2	
	Expansion Bus Connector	Dedicated 100-pin female	
	USB Port	4-pin x 2, USB 2.0	
	I/O Box Connector	Dedicated 36-pin male	
	Modem	RJ-11 jack Data: 56 kbps (V.92) FAX:14.4 kbps	
	LAN	RJ-45 jack IEEE 802.3 10Base-T, IEEE 802.3u 100Base-TX	
	Wireless LAN	802.11b	
Pointing Device		Touch Pad	
Speaker		Card Speaker x 2	
Sound		WAVE and MIDI playback	
Battery Pack	Battery Pack		Li-ion 11.1 V, 3.8 Ah
	Operating Time*6	Main battery	Approx. 5 hours
		Main battery + Second battery	Approx. 9 hours
	Charging Time*6	Main battery	Approx. 3 hours
		Main battery + Second battery	Approx. 6 hours
Clock Battery		Coin type lithium battery 3.0 V	
AC Adaptor*7	Input	100 V - 240 V AC, 50 Hz/60 Hz	
	Output	15.6 V DC, 5.0 A	
Power Consumption*8		Approx. 43 W*9 / Approx. 80 W (maximum when recharging in the ON state)	

*1 A 16M color display is achieved by using the dithering function. **Windows XP** : A 256 color and 640x480 dots are not supported.

*2 Maximum resolution depends on the specifications of the external display. **Windows XP** : A 256 color and 640x480 dots are not supported.

*3 1GB = 10⁹ bytes

*4 Only a RAM card designed for PC2100 can be added.

*5 Use only a monaural condenser microphone.

*6 The numerical value given for the following conditions varies depending on the usage conditions.

LCD brightness: minimum

[Audio Power Management] in the Setup Utility: [Enable]

[Power schemes] in [Power Options]: [Max Battery]

ATI POWERPLAY: [Optimal Battery Life]

Wireless LAN: radio off

*7 The AC adaptor is compatible with power sources up to 240 V AC adaptor.

This computer is supplied with a 125 V AC compatible AC cord.

*8 Approx. 1.0 W when the battery pack is fully charged (or not being charged) and the computer is off.

Approx. 1.2 W when the Wake up from LAN function has been enabled.

*9 Rated power consumption.

● Main Specifications

Model No.		CF-73E3KVXDM/CF-73E3KVXKM	
Environment	In use	Temperature	5 °C to 35°C {41 °F to 95 °F}
		Humidity	30% to 80% RH (No condensation)
	Not in use	Temperature	-20 °C to 60 °C {-4 °F to 140 °F}
		Humidity	30% to 90% RH (No condensation)
Physical Dimensions (W x H x D)		297 mm x 32 - 42.5 mm x 254 mm {11.7 " X 1.2 - 1.7 " X 10 "} (excluding the carrying handle)	
Weight (including the carrying handle)		Approx. 2.2 kg {Approx. 4.9 lb.}	

● Software

Model No.	CF-73E3KVXDM	CF-73E3KVXKM
Operating System	Microsoft® Windows® 2000 Professional with Service Pack3 (NTFS File System)	Microsoft® Windows® XP Professional with Service Pack1 (NTFS File System)
Utility Programs	Setup Utility DMI Viewer Adobe® Acrobat® Reader Hard Disk Data Erase Utility*	

* The Product Recovery CD-ROM is required.

LIMITED WARRANTY

For U.S.A.

PANASONIC PERSONAL COMPUTER AND PERIPHERALS LIMITED WARRANTY

Panasonic Computer Solutions Company (referred to as "Panasonic") will repair this product (other than software, which is covered by a separate warranty) with new or rebuilt parts, free of charge in the U.S.A. for three (3) years from the date of original purchase in the event of a defect in materials or workmanship. This warranty includes the AC adaptor but excludes the batteries and all other options and accessories which are covered for a period of one (1) year from the date of purchase.

This warranty is extended solely to the original purchaser. A purchase receipt or other proof of date of original purchase will be required before warranty performance is rendered.

This warranty only covers failures due to defects in materials or workmanship which occur during normal use. It does not cover damage which occurs in shipment or failures which are caused by products not supplied by Panasonic, or failures which result from alteration, accident, misuse, introduction of liquid or other foreign matter into the unit, abuse, neglect, installation, maladjustment of consumer controls, improper maintenance, modification or service by anyone other than a Factory Service Center or authorized Panasonic Service Dealer, or damage that is attributable to acts of God.

Limits and Exclusions:

There are no other express warranties except as listed below.

PANASONIC SHALL NOT BE LIABLE FOR LOSS OF DATA OR OTHER INCIDENTAL OR CONSEQUENTIAL DAMAGES RESULTING FROM THE USE OF THIS PRODUCT, OR ARISING OUT OF ANY BREACH OF THIS WARRANTY. ALL EXPRESS AND IMPLIED WARRANTIES, INCLUDING THE WARRANTIES OF MERCHANTABILITY AND FITNESS FOR A PARTICULAR PURPOSE ARE LIMITED TO THE APPLICABLE WARRANTY PERIOD SET FORTH ABOVE. Some states do not allow the exclusion or limitation of incidental or consequential damages, or limitations on how long an implied warranty lasts, so the above limitations or exclusions may not apply to you.

This limited warranty gives you specific legal rights, and you may also have other rights which vary from state to state. If a problem with your product develops during or after the warranty period, you may contact our representatives at 1-800-LAPTOP5. If the problem is not handled to your satisfaction, then write to the Consumer Affairs Division at the address indicated below.

SOFTWARE LIMITED WARRANTY

Panasonic Computer Solutions Company (referred to as "Panasonic") warrants to you only that the disk(s) or other media on which the Programs are furnished will be free from defects in materials and workmanship under normal use for a period of sixty (60) days from the date of delivery thereof to you, as evidenced by your purchase receipt.

This is the only warranty Panasonic makes to you. Panasonic does not warrant that the functions contained in the Programs will meet your requirements or that the operation of the Programs will be uninterrupted or error free.

Panasonic's entire liability, and your exclusive remedy under this warranty shall be limited to the replacement, in the United States, of any defective disk or other media which is returned to Panasonic's Authorized Service Center, together with a copy of the purchase receipt, within the aforesaid warranty period.

Anything in the foregoing to the contrary notwithstanding, Panasonic shall have no obligation for any defects in the disk(s) or other media on which the Programs are furnished resulting from your storage thereof, or for defects that have been caused by operation of the disk(s) or other media otherwise than on the Product or in environmental conditions other than those specified by Panasonic by alteration, accident, misuse, abuse, neglect, mishandling, misapplication, installation, maladjustment of consumer controls, improper maintenance, modification of damage that is attributable to acts of God. In addition, Panasonic shall have no obligation for any defects in the disk(s) or other media if you have modified, or attempted to modify any Program.

DURATION OF IMPLIED WARRANTIES, IF ANY, IS LIMITED TO SIXTY (60) DAYS.

PANASONIC ASSUMES NO RISK OF AND SHALL NOT IN ANY CASE BE LIABLE FOR ANY DAMAGES, INCLUDING, WITHOUT LIMITATION, ANY SPECIAL, INCIDENTAL, CONSEQUENTIAL, OR PUNITIVE DAMAGES ARISING FROM BREACH OF WARRANTY OR CONTRACT, NEGLIGENCE OR ANY OTHER LEGAL THEORY, INCLUDING, WITHOUT LIMITATION LOSS OF GOODWILL, PROFITS OR REVENUE, LOSS OF USE OF THE PROGRAMS OR PRODUCTS OR ANY ASSOCIATED EQUIPMENT, COST OF CAPITAL, COST OF ANY SUBSTITUTE EQUIPMENT, FACILITIES, SERVICES, DOWNTIME COSTS, OR CLAIMS OF ANY PARTY DEALING WITH YOU FOR SUCH DAMAGES.

Some states do not allow the exclusion or limitation of incidental or consequential damages, or limitations on how long an implied warranty lasts, so the above limitations or exclusions may not apply to you.

This limited warranty gives you specific legal rights, and you may also have other rights which vary from state to state.

This Limited Warranty will be governed by the laws the State of New York, without regard to its conflict-of-laws rules.

* * *

To obtain service or technical assistance within the continental U.S.A. and Alaska.

DIAL TOLL FREE: 1-800-LAPTOP5

Correspondence requesting product information should be sent to:

Panasonic Computer Solutions Company

50 Meadowlands Parkway, Panazip 2F-5, Secaucus, NJ 07094

For Canada

PANASONIC COMPUTER AND PERIPHERALS LIMITED WARRANTY

Coverage – Panasonic Canada Inc. ("PCI") warrants to you, the first end user customer, this computer product (excluding software media), when purchased from PCI or from a PCI authorized reseller, to be free from defects in materials and workmanship under normal use, subject to the terms set forth below, during the period of warranty coverage specified.

Scope of Coverage	Period of Coverage	Type of Failure Coverage
Whole Product (except Batteries), AC adaptor and CD-ROM (if factory installed)	Three (3) Years from Date of Original End User Customer Purchase	Defective Materials or Workmanship
Batteries, CD-ROM (unless factory installed), Port Replicator, Extra Memory Modules and all other Peripherals, Options and Accessories	One (1) Year from Date of Original End User Customer Purchase	Defective Materials or Workmanship

Remedy – In the event of a warranty claim, contact PCI's representatives within the applicable warranty period, identifying the nature of the defect claimed, at 1-800-668-8386 between 9:00 A.M. and 5:00 P.M., Eastern Time Zone, Mon. – Fri. (excluding holidays) for instructions on how to obtain service. A purchase receipt or other proof of date of original purchase is required before warranty service is performed. Defective parts covered by this Limited Warranty will be repaired or replaced with new or comparable rebuilt parts on an exchange basis. Warranty replacement or repair is subject to the terms of this Limited Warranty for the balance of the original period of warranty coverage.

No Coverage – This Limited Warranty does not cover products purchased outside Canada. Neither does it cover damage to, failure of, or defects in a product or accessory through mishandling, improper installation, abnormal use, misuse, neglect, accident, introduction of liquid or other foreign matter into the product, alteration or servicing by anyone not authorized by PCI, or act of God.

IF YOU SHIP THE PRODUCT FOR WARRANTY SERVICE

Carefully pack the product, preferably in the original carton. Include details of defect claimed and proof of date of original purchase. No liability is assumed for loss or damage to the product while in transit, if you chose your own transportation carrier.

SOFTWARE MEDIA LIMITED WARRANTY

Coverage – Panasonic Canada Inc. ("PCI") warrants to you, the first end user customer, that the disk(s) or other media on which software program(s) is/are supplied will be free from defects in materials and workmanship under normal use in Canada for a period of sixty (60) days from date of receipt as evidenced by your purchase receipt for your Panasonic Computer product.

THIS IS THE ONLY WARRANTY THAT PCI MAKES RESPECTING THE SOFTWARE MEDIA. PCI does not warrant the software. Please refer to the software licensor's written warranty (accompanying the copy of the software) for any software warranty claim.

Claim Procedure – In the event of a defect in material or workmanship in the media during the sixty (60) day warranty period, and you return it, transportation costs prepaid, to Panasonic Canada Inc., Computer Products Marketing, at the above address, within the warranty period, together with a copy of your purchase receipt, and an explanation of the suspected defect, PCI will replace in Canada the defective disk(s) or other media.

Remedy – PCI's entire liability, and your only remedy for any breach of this software media warranty is limited to replacement of the media only. It does not cover any other damages, including, but not limited to, loss of use or profit loss, or special, indirect or consequential damages, or other claims, whether or not of similar character.

No Coverage – This limited warranty does not apply if the disk(s) or other media has been used in other than a Panasonic product, or in environmental conditions other than those specified by PCI or the manufacturer, or if subjected to misuse, neglect, mishandling, modification or attempted modification of the program, or if damaged by accident or act of God. PCI is not responsible for damage to or loss of any program, data or removable storage media.

GENERAL

NO OTHER WARRANTIES – PCI DISCLAIMS ALL OTHER WARRANTIES, EITHER EXPRESS OR IMPLIED, INCLUDING, BUT NOT LIMITED TO, IMPLIED WARRANTIES OF MERCHANTABILITY AND FITNESS FOR A PARTICULAR PURPOSE, WITH RESPECT TO THE SOFTWARE, SOFTWARE MEDIA, COMPUTER PRODUCT, OPTIONS AND ACCESSORIES.

NO LIABILITY FOR CONSEQUENTIAL DAMAGES – IN NO EVENT SHALL PCI BE LIABLE FOR ANY SPECIAL, INDIRECT OR CONSEQUENTIAL DAMAGES ARISING FROM ANY BREACH OF THE LIMITED WARRANTIES SET OUT IN THIS DOCUMENT, OR FROM THE USE OF THE COMPUTER PRODUCT, INCLUDING, WITHOUT LIMITATION, LOSS OF DATA, BUSINESS, PROFIT OR GOODWILL.

IN ANY EVENT, PCI'S MAXIMUM LIABILITY FOR ANY BREACH SHALL NOT EXCEED THE AMOUNT ACTUALLY PAID BY YOU FOR THE COMPUTER PRODUCT.

NO ACTION, REGARDLESS OF ITS BASIS, MAY BE BEGUN AGAINST PCI MORE THAN TWO (2) YEARS AFTER THE CAUSE OF ACTION AROSE.

Statutory Warranties – Some jurisdictions do not allow these limitations or exclusions, so they may not apply to you.



As an ENERGY STAR® Partner, Matsushita Electric Industrial Co., Ltd. has determined that this product meets the ENERGY STAR® guidelines for energy efficiency.

Outline of the International ENERGY STAR® Office Equipment Program

The international ENERGY STAR® Office Equipment Program is an international program that promotes energy saving through the use of computers and other office equipment. The program backs the development and dissemination of products with functions that effectively reduce energy consumption. It is an open system in which business proprietors can participate voluntarily. The targeted products are office equipment such as computers, displays, printers, facsimiles, and copiers. Their standards and logos are uniform among participating nations.

Panasonic Computer Solutions Company
50 Meadowlands Parkway, Panazip 2F-5,
Secaucus, NJ 07094

Panasonic Canada Inc.
5770 Ambler Drive Mississauga,
Ontario L4W 2T3

